



CORROLINE+

Smoothbore Flexible PTFE Hose



CHEMICAL RESISTANT

KINK RESISTANT

SELF CLEANING

FLEXIBLE

HYGIENIC

INTRODUCTION TO CORROLINE⁺

- PTFE - The Optimum Choice For Hose Linings **Page 3**
- Corroline⁺ - The New Product Design from Aflex Hose **Page 4**
- Corroline⁺ Hose Description **Page 5**
- Corroline⁺ Specifications & Properties **Page 6**
- Comparison with Competitors Hose **Page 7**
- How to Order Corroline⁺ Hose Assemblies **Page 8**
- Corroline+ EN 16643 Hose Assembly Electrical Property Grades **Page 9**
- Corroline⁺ Part Number System **Page 10**

HOSE

- Corroline⁺ Hose Liners **Page 11**
- Corroline⁺ External Protection Systems **Page 12**

FLANGE FITTINGS

- Swivel Flange Fittings, Non-Lined **Page 13**
- Flange Fittings, PTFE Lined and Step-Up Adaptors **Page 14**

CAM AND GROOVE FITTINGS (CAMLOCKS)

- Female Cam & Groove Fittings, PTFE Lined and Non Lined **Page 15**
- Male Cam & Groove Fittings, PTFE Lined and Non Lined and Cam Male-to-Flange Adaptors, PTFE Lined **Page 16**

SANITARY TRICLAMP (TRICLOVER) FITTINGS

- Sanitary and Mini-Sanitary Triclamp (Triclover) Fittings **Page 17**
- 90° Elbow Sanitary Triclamp (Triclover) Fittings **Page 18**

HYGIENIC FITTINGS (EUROPEAN)

- DIN 11851 Male and Female Fittings **Page 19**

JIC FITTINGS

- 37° JIC Female Fittings & NPT Male & Female Unions **Page 20**

NPT & BSPT FITTINGS and TUBE FITTINGS

- NPT & BSPT Fixed Male Fittings and NPT Fixed Female Fittings **Page 21**
- BSP 60° Cone Seat Female Unions and Non-Lined Tube Adapter (Grooved Standpipe) Fittings **Page 22**

DIP PIPES

Page 23

CORROLINE⁺ LABELLING & COLOUR CODING

Page 24

CORROLINE⁺ SPECIAL USAGE CONDITIONS

Page 25

QUALITY ASSURANCE, CERTIFICATION & APPROVALS

Page 26

CORRECT HOSE CONFIGURATION & LENGTH CALCULATIONS

- for Bend Radius **Page 27**
- for Abrasion & Torque **Page 28**
- for Length Calculation **Page 29**

CONDITIONS OF SALE

Pages 30 & 31

Section from a PTFE Molecule, 16 Angstrom Units long

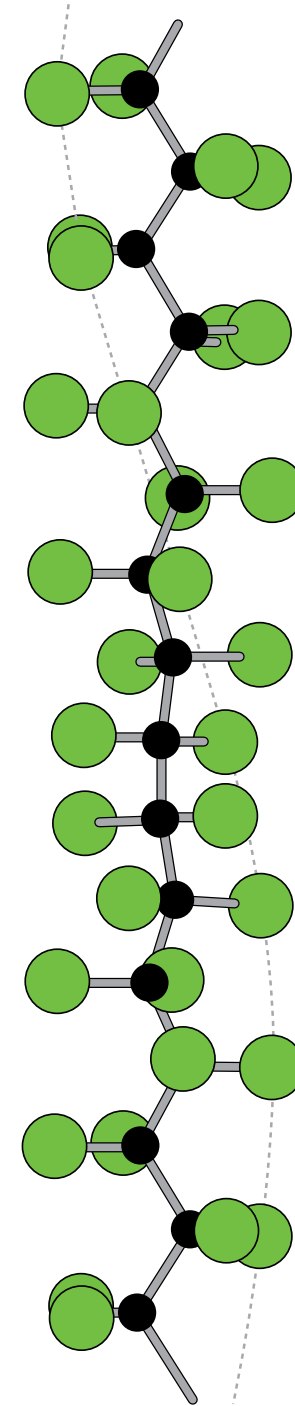

● = Fluorine Atom
● = Carbon Atom

PTFE, or Polytetrafluoroethylene, comprises of long-chain molecules of carbon atoms, each linked to two fluorine atoms.

The fluorine atoms provide a helical spiral which surrounds the carbon chain and protects it.

It is this structure which creates the unique properties for which PTFE is well-known.

• **Excellent Chemical Resistance**

PTFE is renowned as the most chemically resistant material known. Only a very few, very unusual substances and conditions can affect it, like Fluorine gas at high temperature and pressure and liquid, boiling sodium metal.

PTFE lined hoses can therefore be used for a wider variety of chemicals than any other hose type, making it the ideal choice for very corrosive chemical applications and multi-product applications.

• **Non-Stick Surface**

The use of PTFE as a surface for cookware products has demonstrated to the world how easily cleanable PTFE surfaces are.

This means that PTFE lined hoses can be purged 100% clean more quickly, easily and reliably than any other type of hose.

• **Excellent Temperature Range**

The cookware application also demonstrates another of PTFE's many attributes - temperature resistance. PTFE itself can be used as a hose liner at temperatures from -150°C up to +260°C, dependent upon the hose design and the application conditions.

This is the widest temperature range of any rubber or plastic hose lining material.

• **Very High Electrical Resistance**

Most aerospace electrical wiring has a PTFE cover, due to the excellent electrical resistance of PTFE. This property is however, a disadvantage in some hose applications where there is a risk of developing an electrostatic charge inside the hose bore. Aflex Hose have developed a non-contaminant, FDA and USP Class VI compliant solution to this problem.

• **Hose Design**

The only issue with PTFE as a hose lining material is the best way it can be integrated in to the hose design. This is where Aflex Hose have a proven record of success over the last 40 years.

Corroline⁺ - The New Product Design from Aflex Hose

Corroline⁺ Hose Description

CORROLINE⁺ GP HOSE, FITTED WITH A NON-LINED FLANGE FITTING

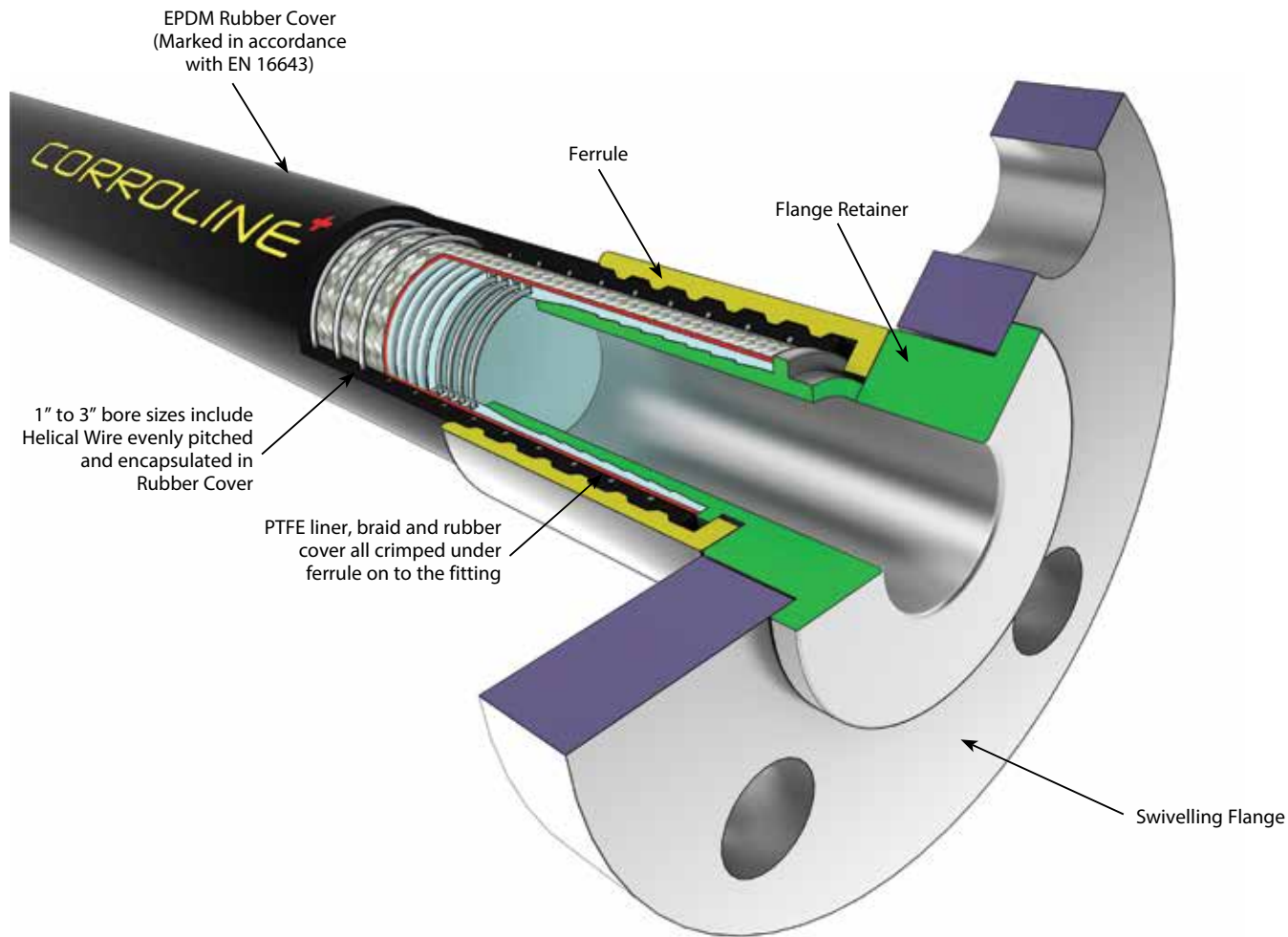

Corroline⁺ Hose

Corroline hose was developed and introduced by Aflex Hose in 2008, specifically to provide customers with a new smooth bore PTFE lined hose which had better flexibility than other chemical hose products which were available.

More recently customers have asked whether Aflex could improve their product further still by improving the kink resistance, while retaining the excellent flexibility.

In response to our customer's requests Aflex Hose have introduced a new version of Corroline, which combines excellent flexibility with exceptional kink resistance - CORROLINE⁺.

Corroline⁺ PTFE Liner Tube

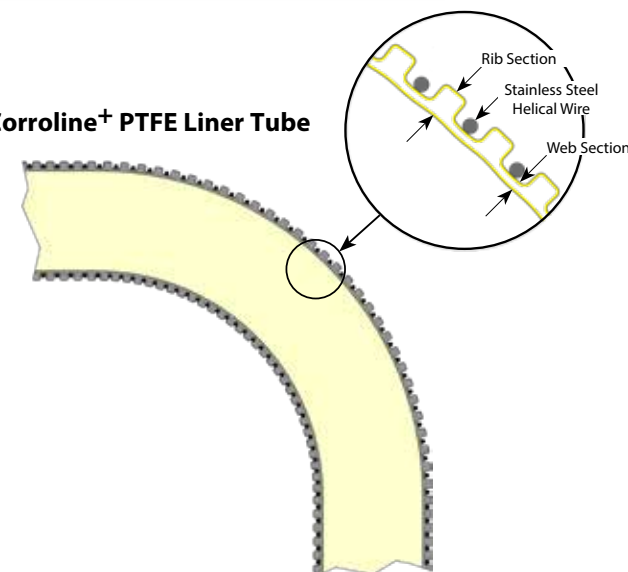

CORROLINE⁺ GP HOSE, FITTED WITH AN INTEGRAL PTFE LINED FLANGE FITTING

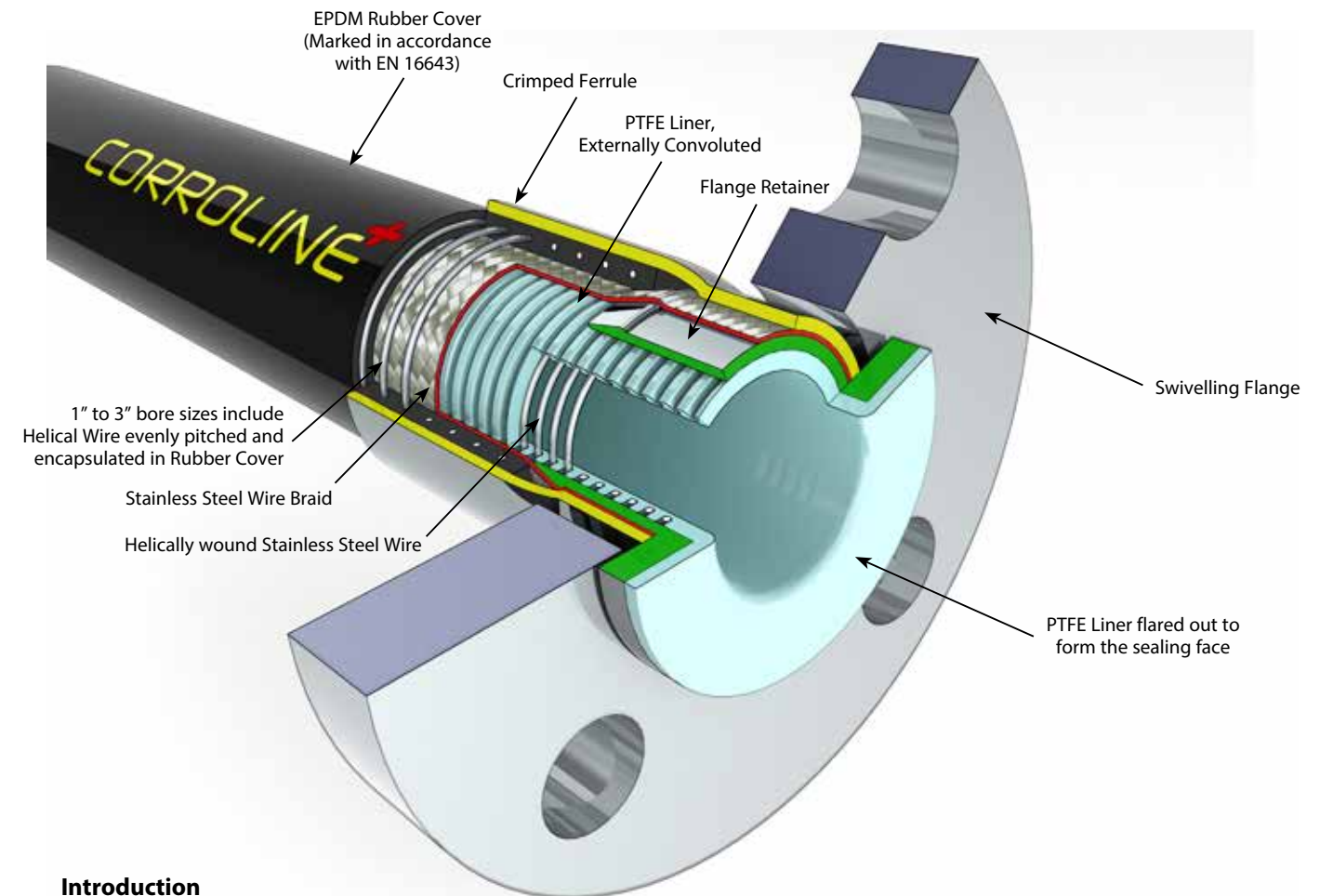

Introduction

Corroline⁺ hose was designed and developed to provide customers with a universal chemical hose product which combined all the requirements they had requested for chemical plant applications, particularly the need for improved flexibility and kink resistance.

Corroline⁺ hose provides a superior alternative to the wide variety of alternative Chemical Hose products currently available.

Construction

Corroline⁺ is built around a unique PTFE hose liner design, which has a slightly rippled smooth bore inside, but convoluted outside to generate excellent flexibility combined with "hoop strength". Grade GP hose has a natural (clear) PTFE liner tube and Grade AS hose has an antistatic (Black) PTFE liner tube.

A stainless helical wire is wound in to the external convolutions, which adds to the kink resistance, crush resistance and the resistance of the hose to both pressure and vacuum.

This reinforced PTFE Liner construction is strong enough to withstand vacuum to -0.9bar and kinking without the need for either internal convolutions or the need to bond the liner to an outer cover, making it an ideal hose liner design, and a significant improvement upon standard products currently available.

The PTFE liner is then further reinforced with a stainless steel wire braid. A smooth finish black antistatic EPDM rubber cover is extruded over the braid, which includes a helical reinforcement wire encapsulated in the rubber cover which renders the hose kinkproof. The rubber cover has a mirror smooth surface finish to aid cleaning, and the antistatic rubber is specially compounded to make the hose 'fireproof'.

Corroline⁺ Hose - The best Flexible Hose for Chemical Plant Applications.

Corroline⁺ Specifications & Properties

Specifications for Corroline⁺ Hose Grades

Nominal Hose Size		Actual Bore Size		Outside Diameter		Maximum Working Pressure		Minimum Bend Radius		Maximum Continuous Lengths		Weight per Unit Length	
in	mm	in	mm	in	mm	psi	bar	in	mm	ft	mtrs	Kg/Mtr	lb/ft
1/2 *	13	0.51	13.1	0.85	21.5	1000	69	1 3/8	38	100	30	0.40	0.27
3/4 *	20	0.76	19.3	1.12	28.5	624	43	2	50	100	30	0.70	0.47
1	25	1.01	25.7	1.45	37.0	600	41	2 3/4	70	100	30	1.10	0.74
1 1/4	32	1.26	32.2	1.75	44.6	550	38	3 5/16	100	100	30	1.60	1.07
1 1/2	40	1.51	38.5	2.03	51.7	500	34	4 3/4	120	100	30	1.92	1.29
2	50	2.01	51.1	2.55	65.0	400	28	5 15/16	150	80	25	2.80	1.88
2 1/2	65	2.51	63.7	3.17	80.5	290	20	11 13/16	300	60	18	3.98	2.67
3	80	3.02	76.8	3.65	92.8	218	15	13 3/4	350	50	15	4.42	2.97

* The 1/2" and 3/4" size hoses do not include the helical wire embedded in the rubber

Pressure and Temperature Limitations

Maximum Working Pressures - as listed above apply from -40°C (-40°F) up to the maximum operating temperature of 150°C (302°F).

Burst Pressures - The hose burst pressures are equal to or more than the maximum working pressures × 4.

Vacuum Limitations

Usable at vacuum to -0.9bar up to 150°C/302°F.

Flexibility

Much less force to bend than any other smooth bore PTFE lined hose product.

Kink resistance

Much more resistant to kinking than any other smooth bore PTFE lined hose product, and much more kink resistant than the previous Corroline product.

Fire resistance

Corroline⁺ hose is Fireproof to BS5173 Section 103.13 Parts 6.2 and 6.3, and Corroline⁺ hose assemblies can be upgraded to Fireproof by applying DBK 300 at each end (see pg 12). All assemblies comply with the flammability requirement as set out in EN 16643.

'Rolling U' Flex Life Test

More than 100 × the flex life to failure compared with all other types of smooth bore PTFE, FEP and PFA lined rubber covered hose products.

Flow rates

More than 2 times the flow rates for convoluted bore hose designs. Consult Aflex Hose for specific flow rate information.

Gas permeability

Reduced gas permeability compared with other PTFE lined hose designs, due to the heavy compression applied to the PTFE during processing, which reduces porosity.

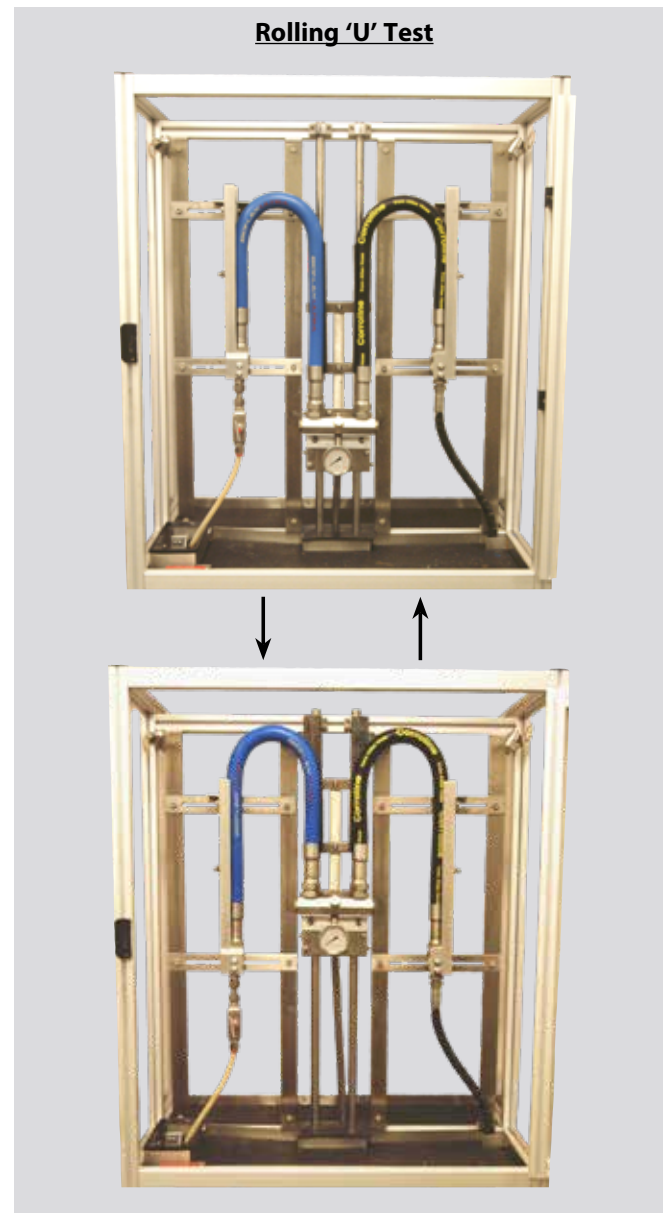

Comparison with Competitors Hose

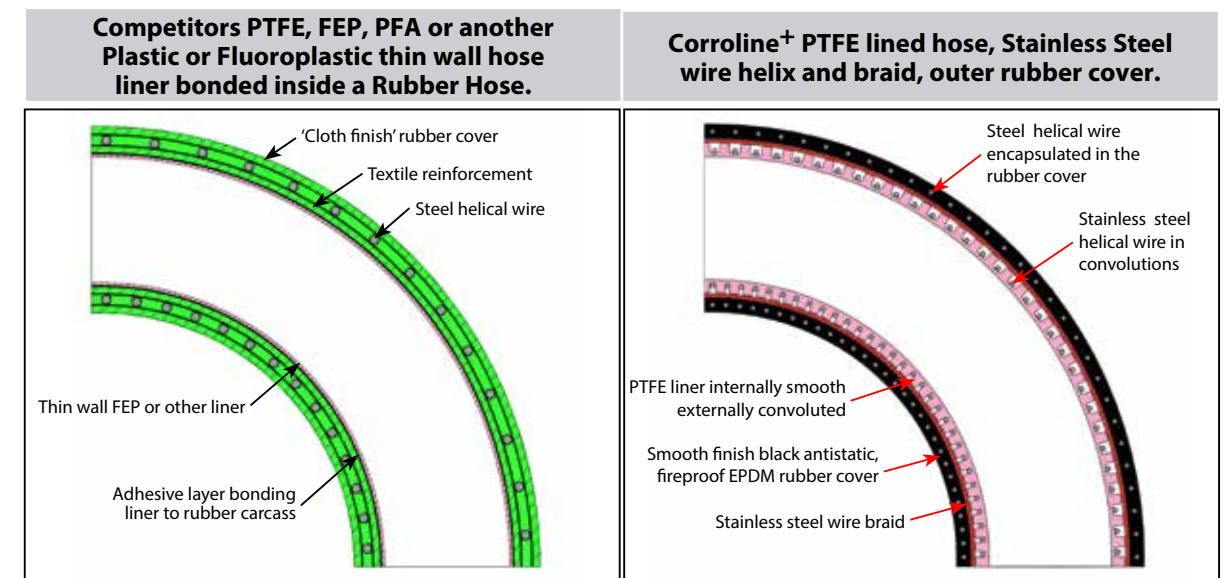

Property	Competitor	Corroline ⁺
Bore Profile	Smoothbore, but internal profile collapses into large uneven ripples when flexed	Smoothbore internal profile slightly rippled, ripples increase evenly when flexed
Liner Material	FEP or another Fluoroplastic liner, - Good but not as good as PTFE XLPE or UHMWPE - Fair chemical resistance	PTFE Liner - Best for chemical resistance and temperature resistance
Process Fluid Contamination Risk	High Risk - adhesive layer can leach in to contaminate the process fluid through pinholes in the thin wall liner, caused by static discharge, flex induced porosity, hose kinking etc.	No Risk - no adhesive layer - no non-FDA approved materials present in the hose construction
Flexibility	Fair to Poor - Very stiff, with a large minimum bend radius	Good - More flexible, reduced minimum bend radius
Flex Life (Rolling 'U' Test)	Poor, typically from 1000 to 7000 cycles to failure	Excellent 100,000+ cycles without failure
Kink Resistance	Good	Excellent
Cut Through or Puncture Resistance	Fair (Textile braid protection)	Good (Stainless Steel Wire Braid Protection)
Antistatic Liner Quality to FDA Requirements (<2.5% High Purity Black)	Often more than 2.5% Black (non-FDA), often unevenly dispersed, leading to carbon agglomerates which contaminate Process Fluid	Always less than 2.5% Black, very evenly dispersed and guaranteed agglomerate-free. 'Leachable and Extractable' testing yields zero carbon
Fire Resistance	Not tested or approved to be Fireproof	Tested and approved 'Fireproof' to BS5173 Section 103.13

How to Order Corroline⁺ Hose Assemblies

Corroline Hose Assemblies

Corroline⁺ hose is custom built into hose assemblies after the hose size and grade, length and end fittings have been selected.

The specification and information contained in this brochure can be used to make these selections, but if there are any doubts concerning the hose usage limitations or performance capabilities, customers should request expert advice from Aflex Hose.

Selecting the Hose Grade

There are two types of PTFE hose liner tube available, natural (GP) grade and antistatic black (AS) grade, fully described on page 11

If needed there are 3 options for extra protection of the hose against externally applied abrasion and mechanical damage, fully described on page 12:

- Double Rubber Cover end protection cuffs (DBK)
- Safeguard HDPE spiral-wrap for abrasion protection (SG)
- Helically wound, heavy gauge SS wire outer Protection Coil (PC)

Selecting the Hose Assembly Length

The lengths of Corroline⁺ hose assemblies are as specified by the customer and the length is measured from the sealing face at one end fitting to the same at the other end of the hose.

Length tolerances are normally -0% +2%.

Maximum lengths are given under Specifications on page 6

Minimum lengths can be calculated from the configuration data on pages 27 - 29.

Selecting the End Fittings

The range of non-lined standard PTFE tail end fittings and materials are given on pages 13 - 23

Flange fittings and Cam and Groove fittings are available either non-lined, or with integral PTFE lined and flared ends, see pages 14-16

Stainless Steel End Fitting Materials

Non-Lined Spigots - are all made from Grade 316L SS

PTFE Lined Spigots - are all made from Grade 316L or Grade 316C SS

Cam and Groove Female Fittings - are made from Grade 316C SS (Body) and 316L SS (Spigot)

Swivelling Nuts and Flanges - are all made from Grade 304 SS

Ferrules - most ferrules are made from Grade 304 SS, except some which are made from Grade 316L SS. Consult Aflex Hose if necessary.

The equivalent specification for the different Grades of Stainless Steel are listed below:

Specification Equivalent List

Grade	BS - British Standards	AISI - American Standard or C = Casting Grade	EN - European Norm
316L SS	BS 316 S11	AISI 316 L	EN 1.4404
316C SS	BS 316 C16	CF8M	EN 1.4408
304 SS	BS 304 S15	AISI 304	EN 1.4301

*To special order, end fittings components can be made in non-standard grades of SS such as 1.4571, 1.4435, or other materials such as Hastelloy or Monel

How to Order

The quantity, hose size, grade, length and fittings must be specified in full.

Either by a full, written description. The hose grade can be specified by the code initials e.g. 'Corroline⁺ AS, SG' defines an antistatic PTFE lined hose which includes an outer Safeguard sleeve.

The quantity, length and fittings can then be written in - e.g. "4 off x 1" bore Corroline⁺ AS, SG hose x 3.00 metres long. Both ends non-lined ANSI 150# S/S Flanges".

Or by Part Numbers, as defined on page 10 - e.g. 4 off Part No. 16-CLN+AS-SG-3.00m-12-12

Any special requirements relating to the hose construction, or information required on Tags, or Certificates, or special testing requirements, must be specified in full on the enquiry or purchase order.

Conditions of Sale

Corroline⁺ hose and hose assemblies are only supplied on the basis that the customer has read and accepted the Conditions of Sale as given on pg's 30 & 31. Customers own Conditions of Sale (or equivalent) are not accepted unless an acceptance signed by a Director of Aflex is supplied.

Corroline⁺ EN 16643 Hose Assembly Electrical Property Grades

The hose assembly electrical property grades and electrical resistance limits are defined within EN 16643 and tested in accordance with BS EN ISO 8031. Aflex Hose electrically conductive (**EC**) assemblies are defined in EN 16643 as *electrically bonded* and given the symbol **M**. M-grade assemblies exhibit a maximum electrical resistance of 100Ω between end fittings. Aflex Hose anti-static (**AS**) PTFE liners and rubber covers are termed *static dissipative* within EN 16643 and given the symbol **Ω** followed by letters that specify either the liner, cover or both; **L**=liner, **C**=cover, **CL**= cover & liner. Ω-grade covers or liners exhibit an electrical resistance of 10³-10⁸Ω.

The table below identifies each EN 16643 electrical grade for a hose assembly along with a brief description and example assembly configuration.

EN16643 Electrical Grade For Hose Assembly	EN16643 Description	Example Hose Assembly
Grade M	Electrically bonded without static-dissipative lining or cover	Not available
M/Ω-L	Electrically bonded and static-dissipative lining	Not available
M/Ω-C	Electrically bonded and static-dissipative cover	CLN+ Ends ASA150 Lined
M/Ω-CL	Electrically bonded and static-dissipative cover and lining	CLN+AS Ends ASA150 Lined
I	Electrically insulated (no electrical bonding AND no static-dissipative layers)	Not available
Ω-L	Static dissipative lining without electrical bonding	Not available
Ω-C	Static dissipative cover without electrical bonding	CLN+ Ends ASA150 PP spigot and flange (special order)
Ω-CL	Static dissipative cover and lining without electrical bonding	CLN+AS Ends ASA150 PP spigot and flange (special order)

Part Numbers for Corroline⁺ Hose Assemblies

If required, Corroline⁺ Hose Assemblies can be defined by an individual Part Number, made up of **5** entries as below:

1	Hose Size	Size Part No.
	1/2"	08
	3/4"	12
	1"	16
	1 1/4"	20
	1 1/2"	24
	2"	32
	2 1/2"	40
	3"	48

2	Hose Type	Type Part No.
	Corroline ⁺ GP (Natural PTFE Liner)	CLN+
	Corroline ⁺ AS (Antistatic PTFE Liner)	CLN+AS

3	External Protection	Type Part No.
	Double Rubber Cover	DBK
	Safeguard HDPE Sleeve	SG
	S/S Wire Protection Coil	PC

4	Length
	The overall hose length between the sealing faces at each end is given as the Length Part No either in decimal Metres followed by 'm' or inches followed by 'in'

5 & 6	Assembled End Fitting Description * All Components in Stainless Steel N/L = Not PTFE Lined, PTFE/L = PTFE Lined and Flared	End Fitting Part No.
	N/L JIC Female	02
	N/L Fixed Male Pipe, NPT Thread	03
	N/L Fixed Female Pipe, NPT Thread	06
	N/L JIC-to-NPT Male Union	08
	N/L JIC-to-Female Union	08F
	N/L Straight Sanitary Tri Clamp, 50.5mm, 1.984" Diameter	-
	22mm, 0.870" Exit Diameter (Standard)	10
	34.9mm, 1.370" Exit Diameter (Set Up)	10/S
	N/L Straight Mini Sanitary Tri Clamp, 0.984" Diameter	-
	0.370" Exit Diameter (Standard)	11
	0.625" Exit Diameter (Step-Up)	11/S
	N/L *ANSI 150# Swiveling Flange	12
	PTFE/L *ANSI 150# Swiveling Flange	12L
	N/L Cam and Groove, Locking Arm Swiveling Female	16
	PTFE/L Cam and Groove, Locking Arm Female	16L
	N/L Cam and Groove Male	17
	PTFE/L Cam and Groove, Male	17L
	N/L DIN 11851 Female	23
	PTFE/L DIN 11851 Female	23L

Notes - For Flange only: Add '/ZP' for Carbon Steel Zinc Plated

Elbows: Add '/90°' for Non-Lined 90° elbows or, add '/90° L' for PTFE Lined 90° elbows

Additional Requirements:

- Any additional requirements which are not included in the Part Number must be written out in full in the Order, including any special labelling or colour coding.

- When purchasing Triclovers/Sanitary Fittings please specify the surface finish required.

Example:

A 3/4" bore Corroline⁺ Hose Assembly with an Antistatic PTFE Liner and an outer Safeguard Sleeve with:

End (1) - a 3/4" ANSI 150# Swivel Flange, PTFE Lined

End (2) - a Cam and Groove Swivelling Female, PTFE Lined

and a Length of - 2.35 metres

Hose Assembly Part No. = 12 - CLN+AS - SG - 2.35m - 12L - 16L

Entry No.	1	2	3	4	5	6
-----------	---	---	---	---	---	---

Corroline⁺ Hose Liners

GP - General Purpose Liner



Purpose

Corroline⁺ GP is the 'General Purpose' grade, for use in all applications where fluids or gases are being conveyed which do not generate a risk of static charge development (see 'AS').

Materials & Specifications

Corroline⁺ GP is a virgin PTFE liner, manufactured from hose grade PTFE which conforms to the requirements of: FDA 21 CFR 177.1550.

The helical reinforcement in the convolutions in the liner is High Tensile Grade 316 SS wire. The helical reinforcing wire embedded in the rubber cover is carbon steel. The specially compounded, black EPDM rubber cover is antistatic in accordance with EN ISO 8031 Annex A and a stainless steel braid.

GP & AS grade approvals

The full list of approvals and certifications are given on page 26.

FIREPROOF



Corroline⁺ GP and AS grade hose is Fireproof to BS5173 Section 103.13 Part 6.2 and 6.3. When end fittings are assembled to the hose, the assembly is Fire Resistant, but can be made Fireproof by adding DBK-300 rubber cover end protection. Corroline⁺ meets the requirements of German safety regulation TRbF 131/2 and EN 16643 flame resistance.

SPECIAL NOTE:

Electrical Continuity (Also known as 'Electrically Bonded')

Electrical continuity requires that the hose assembly supplied is electrically continuous, or conductive, between metal end fittings at each end of the hose. This can apply whether the hose is GP or AS grade.

The requirements for this are specified in the German Document BRG 132 and EN 16643, when tested in accordance with EN ISO 8031, which requires that the resistance between end fittings shall be <10² Ohms per assembly. For hose assemblies which meet this requirement a Grade 'M' marking is applied in accordance with EN 16643.

Corroline⁺ Hose Assemblies are all electrically continuous with a resistance of less than 100 ohms.

AS - Anti-Static PTFE Liner



Purpose

Corroline⁺ AS is an essential requirement in applications where there is the risk of an electrostatic charge build-up on the inside surface of the PTFE tube which may then discharge through the tube wall. Media passing through which create such a risk are fluids which have a Conductance of less than 10⁻⁸ S/m (Siemens per Metre), or 10⁴ pS/m such as fuels, solvents, freons, some WFI (ultra-pure 'Water for Injection') and non-polar organics which are being transferred at a medium to high flow velocity.

All twin or multi phase media, and any non-mixing media, such as powder in air, or water droplets in steam, in gases or in oil, also colloidal fluids constitute a particular hazard for static charge generation, and always require grade AS.

If in doubt, consult Aflex Hose.

Materials & Specifications

Corroline⁺ AS is an anti-static PTFE liner manufactured from FDA 21 CFR 177.1550 approved PTFE, and less than 2.5% of 'high purity' Carbon Black material to FDA requirement 21 CFR 178.3297 and European Commission Directive 2007/19/EC. The carbon is encapsulated by the PTFE, and in normal, non-abrasive applications will not come loose to contaminate any fluid passing through. This has been proved during Leachables and Extractables testing.

Antistatic Hose Assemblies

When 'AS' (Antistatic) grade hose is specified, then the hose or hose assembly supplied will be tested in accordance with EN ISO 8031 and meet the Antistatic requirements of EN 16643. This requires, for an antistatic liner or antistatic cover, that the resistance between an appropriately placed foam electrode and a metallic end fitting will be between 10³ to 10⁸ Ohms per assembly. For hose assemblies which meet these requirements an appropriate Grade 'Q' marking is applied in accordance with EN 16643.

NOTE: When in service, at least one end fitting must be connected to earth, to permit dissipation of the static charge from the end fitting.

Corroline⁺ External Protection Systems

SG - Safeguard Protections Sleeve



Purpose

To protect the hose from excessive external abrasion and mechanical damage in rough applications..

Design

A lightweight black HDPE (High Density Poly Ethylene) 'Safeguard' strip is spirally wound along the hose and secured by crimping at each end.

Limitations

Temperature Range -40°C (-40°F) up to 110°C (230°F).

Internal fluid temperatures up to +140°C (284°F) are acceptable, when external temperatures are ambient.

The minimum hose assembly length must be doubled if Safeguard is being used, and the maximum assembly lengths for all sizes are capped at 20 metres (65 feet).

Safeguard is available with anti-static properties and complies with the requirements of a static-dissipative cover within EN 16643 (see page 9 for further information). Request details upon enquiry.

DBK 300 - Double Rubber Cover End Protection



Purpose

In applications where the hose assembly may be mechanically abused by pulling the hose with excessive force at an angle to a connected end fitting. Also to render a hose assembly 'Fireproof' by protecting the end fitting area against the effects of fire.

Design

A second layer of rubber is applied and vulcanised directly on to the hose and the end fitting ferrule, 12" (300mm) along the hose from the fitting.

PC - Protection Coil



Purpose

To protect the hose from excessive external abrasion and mechanical damage in rough applications without the temperature limitations which apply to the Safeguard sleeve.

Design

A large diameter stainless steel wire is spirally wrapped on to the rubber cover, and welded to the ferrule at each end.

Maximum assembly lengths for all sizes are capped at 20 metres (65 feet)

Corroline⁺ Non-Lined Swivel Flange Fittings

End Fitting Specifications

- ANSI B16.5 (also ASME B16.5) Class 150# and 300#
 - DIN PN10, PN16 and PN40*
 - JIS 10K
 - Other Pressure Ratings and Flange Specifications are also available.
- *DIN PN10, PN16 and PN40 Flanges all have the same dimensions, and so are fully interchangeable*

Temperature and Pressure Ratings

- ANSI 150# = 16 Bar (230 psi), ANSI 300# = 41.4 Bar (600 psi)
- DIN PN10 = 10 Bar (145 psi), DIN PN16 = 16 Bar (230 psi)
- DIN PN40 = 40 Bar (580 psi)

End Fitting Materials

- Flanges normally in Grade 304 SS, or Grade 316 SS if required
- Flange Retainers in Grade 316L SS
- Ferrules, most in Grade 304 SS, some sizes in Grade 316 SS

Alternative Options for Flange Component only:

- Zinc Plated Carbon Steel
- Grade 316 SS

Surface Finish :

- All surface finishes are to ASME BPE-SF-O (No finish required).
- If a specified finish on a particular surface is required, please state on the enquiry and order.

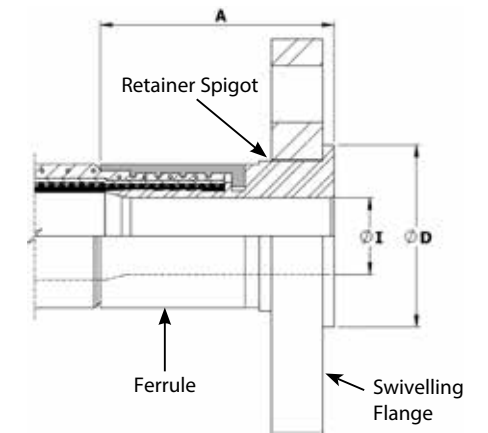

Nominal Hose Size		Fitting Length A ASA150		Flared Diameter D ASA150		Fitting Inside Diameter I ASA150		Weight of Fitting	
in	mm	in	mm	in	mm	in	mm	Kg	Lbs
1/2	13	1.67	42.50	1.38	35.00	0.37	9.40	0.57	1.25
3/4	20	1.86	47.24	1.69	42.90	0.62	15.75	0.84	1.84
1	25	2.36	60.00	2.00	50.80	0.85	21.50	1.20	2.63
1 1/4	32	2.67	67.72	2.50	63.50	1.03	26.21	1.59	3.50
1 1/2	40	2.75	69.86	2.87	73.00	1.25	31.75	2.15	4.73
2	50	3.20	81.22	3.62	92.00	1.76	44.60	2.92	6.41
2 1/2	65	3.70	94.00	4.13	105.00	2.25	57.15	4.36	9.59
3	80	3.74	95.00	5.00	127.00	2.63	66.7	6.02	13.24

Nominal Hose Size		Fitting Length A PN10/16		Flared Diameter D PN10/16		Fitting Inside Diameter I PN10/16		Weight of Fitting	
in	mm	in	mm	in	mm	in	mm	Kg	Lbs
1/2	13	1.79	45.50	1.77	45.00	0.37	9.40	0.78	1.72
3/4	20	2.11	53.50	2.28	58.00	0.62	15.75	1.12	2.47
1	25	2.44	62.00	2.68	68.00	1.12	28.50	1.43	3.15
1 1/4	32	2.70	68.50	3.07	78.00	1.03	26.21	2.35	5.17
1 1/2	40	2.91	74.00	3.49	88.00	1.70	43.10	2.76	6.06
2	50	3.50	89.00	4.02	102.00	2.15	54.50	3.62	7.96
2 1/2	65	3.62	92.00	4.80	122.00	2.25	57.15	4.58	10.07
3	80	3.74	95.00	5.43	138.00	2.63	66.70	6.03	13.26

Corroline⁺ Integral PTFE Lined Flange Fittings & 'Step - Up' Design

Flange Specifications

- ANSI B16.5 (also ASME B16.5) Class 150# and 300#
- *DIN PN10, PN16 and PN40
- JIS 10K
- Other Pressure Ratings and Flange Specifications are also available.

*DIN PN10, PN16 and PN40 Flanges all have the same dimensions, and so are fully interchangeable

Maximum Pressure Ratings for Flange Fittings

- ANSI 150# = 16 Bar (230 psi), ANSI 300# = 41.4 Bar (600 psi)
- DIN PN10 = 10 Bar (145 psi), DIN PN16 = 16 Bar (230 psi)

Integral PTFE Lined Flange Fittings



End Fitting Materials

- Flanges in Grade 304 SS
- Flange Retainers in Grade 316L SS
- Ferrules, most in Grade 304 SS, some sizes in Grade 316 SS

Alternative Options for Flange Component only:

- Zinc Plated Carbon Steel
- Grade 316SS

90° Elbow Flange Fittings

- 90° Elbow Integral PTFE lined Flange Fittings are available for sizes 1", 1 1/2" and 2" - Consult Aflex Hose for details.

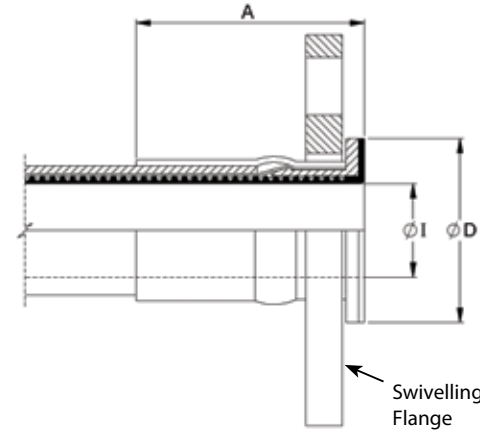

Nominal Hose Size	Fitting Length A ASA		*Fitting Length A PN		Flared Diameter D				Fitting Inside Dia. & Hose Bore I	Recommended Bolt Tightening Torques		Weight of Fitting			
	in	mm	in	mm	ASA 150#		DIN PN10/16/40			ft.lbs	mtr.kgs	Kg	Lbs		
1/2	13	2.24	57.0	2.28	58	*1.25	*32	*1.25	*32	1/2	13.2	8	1.10	0.54	1.20
3/4	20	1.89	48.0	1.93	49	1.69	43	*1.97	*50	3/4	19.4	8	1.10	0.88	1.90
1	25	2.40	61.0	2.48	63	2.00	50	*2.50	*63	1	25.2	10	1.40	0.96	2.10
1 1/4	32	2.24	57.0	2.32	59	2.48	63	3.10	78	1 1/4	32.0	12	1.66	1.15	2.53
1 1/2	40	2.36	60.0	2.44	62	2.875	73	3.50	88	1 1/2	38.6	15	2.10	1.75	3.80
2	50	2.72	69.0	2.91	74	3.625	92	4.00	102	2	51.2	25	3.50	2.70	5.95
2 1/2	65	4.86	123.5	4.86	123.5	4.13	105	4.80	122	2 1/2	63.7	30	40.18	4.21	9.26
3	80	5.17	131.4	5.17	131.4	5.00	127	*5.00	*127	3	76.8	40	53.94	4.75	10.44

*The listed Flare Diameters are not all full size due to limitations on PTFE flare diameters.

'Step-Up' PTFE Lined Flange Fitting Design for Corroline Hose

Because Corroline⁺ Hose has better flow rates than some larger bore sizes of Convuluted PTFE hose, it represents a superior alternative when fitted with the larger size flanges in some applications.

It is, however, necessary to also "Step-Up" the PTFE-lined bore, to ensure a diameter match with the mating connector.

This is best achieved using a solid PTFE Adaptor Plate, as shown in the drawing.

Example: a 2" hose to 3" ANSI 150# PTFE Lined Flange Joint >

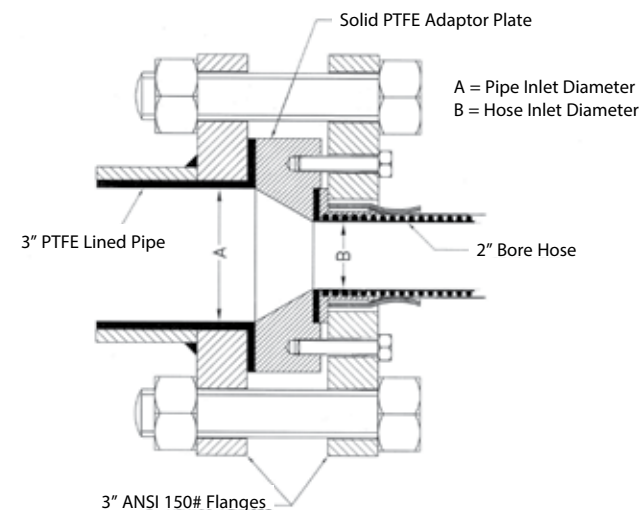

Corroline⁺ Female Cam & Groove Fittings PTFE Lined & Non-Lined

End Fitting Specifications

- Generally in accordance with A-A-59326 (replaces MIL-C-27487) and EN14420-1 (replaces DIN 2828), and all are fully interchangeable.

End Fitting Materials

- Spigot in Grade 316L SS
- Body in Grade 316C SS
- Ferrules, most in Grade 304 SS, some sizes in Grade 316L SS
- Standard Gasket is Buna N (Nitrile) Rubber.
- FEP encapsulated Silicone Rubber Gaskets also available.

Surface Finish: (Non-Lined Fittings only)

- All surface finishes are to ASME BPE-SF-O (No finish required).
- If a specified finish on a particular surface is required, please state on the enquiry and order.

Temperature and Pressure Ratings

- When used with a Buna N Gasket all sizes up to 16 Bar (230 psi) and up to a maximum temperature of 65°C (149°F).
- When used with FEP, Fluoro Rubber or other encapsulated gaskets all sizes up to 10 Bar (145 psi) and up to a maximum temperature of 204°C (400°F).

90° Elbow Cam & Groove Fittings (PTFE Lined Only)

- 90° Elbow Integral PTFE lined Cam & Groove Fittings are available for sizes 1", 1 1/2" and 2" - Consult Aflex Hose for details.

Notes for Integral PTFE Lined Fittings Only:

- FEP Gaskets require higher clamping forces to flatten the Seal and make the joint. This is made easier by 'pre-setting' these gaskets by clamping Polypropylene Cam Male Inserts to the assembled fittings, which must then be kept in place during storage, until use.
- Any Customer's Own 'Special' Gaskets must be pre-supplied to Aflex for special assembly and testing of hose assemblies, to ensure suitability.

Swivelling, Locking Arm Female Cam and Groove Fittings - Non-Lined

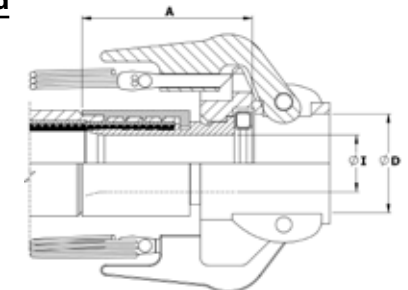

Nominal Hose Size		*Fitting Length A		Cam Sleeve Inside Diameter D		Fitting Inside Diameter I		Weight of Fitting	
in	mm	in	mm	in	mm	in	mm	Kg	Lbs
3/4	20	2.10	53.00	1.26	32.0	0.62	15.75	0.58	1.28
1	25	2.32	59.00	1.45	37.0	0.85	21.50	0.72	1.58
1 1/4	32	2.54	64.60	1.81	46.0	1.03	26.21	1.10	2.42
1 1/2	40	2.65	67.20	2.12	54.0	1.25	31.75	1.21	2.66
2	50	3.11	79.00	2.52	64.0	1.76	44.60	1.48	3.26
2 1/2	65	2.99	76.00	3.01	76.5	2.25	57.15	1.42	3.12
3	80	2.80	71.00	3.63	92.2	2.63	66.70	1.88	4.14

Fixed or Swivelling, Locking Arm Female Cam and Groove Fitting - Integral PTFE Lined

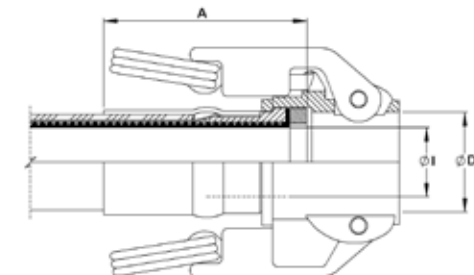

Nominal Hose Size		*Fitting Length A		Cam Sleeve Inside Diameter D		Fitting Inside Diameter I		Weight of Fitting	
in	mm	in	mm	in	mm	in	mm	Kg	Lbs
3/4	20	2.16	54.75	1.26	32.0	0.76	18.6	0.42	0.93
1	25	2.72	69.00	1.46	37.0	1.01	25.2	0.59	1.30
1 1/4	32	2.56	65.50	1.81	46.0	1.26	32.0	0.98	2.16
1 1/2	40	2.61	66.35	2.13	54.0	1.53	38.6	1.15	2.50
2	50	2.97	75.35	2.52	64.0	2.03	51.2	1.40	3.08
*2 1/2	65	5.31	135.0	3.01	76.5	2.36	60.0	1.17	2.57
*3	80	5.45	138.4	3.63	92.2	2.87	73.0	1.40	3.07

*PTFE lined 2 1/2" and 3" sizes are fixed only

Corroline⁺ Male Cam & Groove Fittings & Lined Flange Adaptors

End Fitting Specifications

- Generally in accordance with A-A-59326 (replaces MIL-C-27487) and EN14420-1 (replaces DIN 2828), and all are fully interchangeable.

Temperature and Pressure Ratings

- Temperature and pressure determined by the type of gasket in the Female connecting component and the hose grade.

End Fitting Materials

- Fittings in Grade 316L SS
- Ferrules, most in Grade 304 SS, some sizes in Grade 316L SS
- Adaptor Flange Only in Grade 304 SS

Surface Finish: (Non-Lined Fittings only)

- All surface finishes are to ASME BPE-SF-O (No finish required).
- If a specified finish on a particular surface is required, please state on the enquiry and order.

Non-Lined Cam & Groove Male Fitting

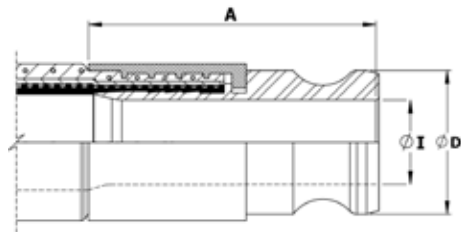

Integral PTFE Lined Cam & Groove Male Fitting

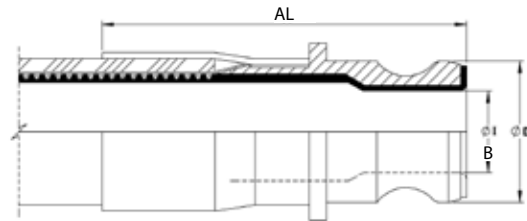

Nominal Hose Size		Outside Diameter D		Non-Lined Fitting Length A		Non-Lined Inside Diameter I		PTFE Lined Fitting Length AL		PTFE Lined Inside Diameter B		Weight of Fitting Non-Lined		Weight of Fitting PTFE Lined	
in	mm	in	mm	in	mm	in	mm	in	mm	in	mm	Kg	Lbs	Kg	Lbs
3/4	20	1.26	32.0	2.40	61.0	0.62	15.75	2.82	71.58	0.71	18.6	0.22	0.49	0.35	0.77
1	25	1.46	37.0	3.00	77.0	0.85	21.50	3.74	95	0.81	20.7	0.33	0.72	0.45	0.99
1 1/4	32	1.79	45.5	3.54	90.0	1.03	26.21	3.62	92	0.97	24.8	0.57	1.25	0.45	1.09
1 1/2	40	2.11	53.5	3.70	94.0	1.25	31.75	3.98	101	1.35	33.5	0.78	1.71	0.84	1.85
2	50	2.48	63.0	4.45	113.0	1.76	44.60	4.61	117	1.72	41.5	1.08	2.37	1.10	2.42
2 1/2	65	2.98	75.8	4.13	105.0	2.23	56.6	6.50	165	2.17	55.0	1.22	2.68	1.17	2.57
3	80	3.60	91.5	4.76	120.8	2.87	73.0	6.98	177.4	2.84	72.2	1.79	3.94	1.45	3.20

PTFE Lined Male Cam & Groove X Flange Adaptors

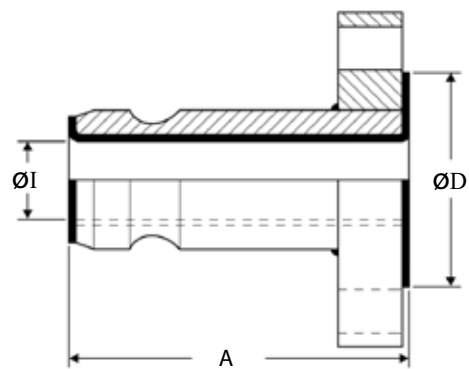

AS Grade PTFE Liner GP Grade PTFE Liner



Cam Action Adaptor Size		Flange Size & Specification		ØD		A		ØI		Weight of Fitting	
in	mm	in	mm	in	mm	in	mm	in	mm	Kg	Lbs
1	25	1" ANSI 150	2.00	50	4 1/8	105	0.84	21	1.246	2.75	
1	25	DN25/PN16	2.58	64	4 1/8	105	0.84	21	1.538	3.39	
1 1/2	40	1 1/2" ANSI 150	2.87	73	4 3/8	118	1.35	34	2.228	4.92	
1 1/2	40	DN40/PN16	3.47	88	4 3/8	118	1.35	34	2.753	6.07	
2	50	2" ANSI 150	3.63	92	4 3/8	118	1.69	43	3.359	7.40	
2	50	DN50/PN16	4.00	102	4 3/8	118	1.69	43	3.714	8.19	

Note: Other Flange Specifications and Pressure Ratings are also available. Non-Lined adaptors and Female Cam & Groove X Flange Adaptors are also available, to special order.

Corroline⁺ Sanitary & Mini-Sanitary Triclamp (Triclover) Fittings

Introduction

There are many different specifications, dimensions and surface finishes for triclamp fittings. Triclosures are covered by various standards, the most widely used are in the tables displayed below. However most standards can be supplied if given the information below. Triclosures can be supplied as 3A.

- Flange diameter D and Outlet diameter I
- Hose size if known, or Aflex can recommend a hose size to suit
- The internal Surface Finish, Standard if known.

Standards

- DIN 32676 SERIES A
- DIN 32676 SERIES B (ISO 1127)
- DIN 32676 SERIES C (ASME BPE)

End Fitting Materials

- Fittings in AISI 316L = EN 1.4404 = BS 316 S11
- Ferrules, most in Grade 304 SS, some sizes in Grade 316L SS
- Fittings for DIN32676 are available in 1.4435 (316L)
- Fittings in 1.4571, Hastelloy, Monel, PVDF and other materials to special order

Standard Fittings Available:

DIN 32676 SERIES A (DIN)							
Nominal Hose Size		Flange Diameter D		Outlet Diameter I		*Fitting Length A	
in	METRIC DN	in	mm	in	mm	in	mm
1/4	6	0.984	25.0	0.236	6	1.299	33
5/16	8	0.984	25.0	0.315	8	1.654	42
3/8	10	1.339	34	0.394	10	1.969	50
1/2	15	1.339	34	0.630	16	1.969	50
3/4	20	1.339	34	0.787	20	1.969	50
1	25	1.988	50.5	1.024	26	2.283	58
1 1/4	32	1.988	50.5	1.260	32	2.441	62
1 1/2	40	1.988	50.5	1.496	38	2.638	67
2	50	2.520	64	1.969	50	3.071	78
2 1/2	65	3.583	91	2.598	66	2.953	75
3	80	4.173	106	3.189	81	3.169	80.5

DIN 32676 SERIES B (ISO)							
In	METRIC DN	in	mm	in	mm	in	mm
1/4	10.2	0.984	25.0	0.276	7	1.299	33
5/16	13.5	0.984	25.0	0.406	10.3	1.654	42
3/8	17.2	0.984	25.0	0.551	14	1.969	50
1/2	21.3	1.988	50.5	0.713	18.1	1.969	50
3/4	26.9	1.988	50.5	0.933	23.7	1.969	50
1	33.7	1.988	50.5	1.169	29.7	2.283	58
1 1/4	42.4	2.520	64	1.512	38.4	2.441	62
1 1/2	48.3	2.520	64	1.744	44.3	2.638	67
2	60.3	3.051	77.5	2.217	56.3	3.071	78
2 1/2	76.1	3.583	91	2.839	72.1	2.953	75
3	88.9	4.173	106	3.319	84.3	3.169	80.5

ASME BPE (DIN 32676 SERIES C)							
in	in	mm	in	mm	in	mm	mm
1/4	0.984	25.0	0.180	4.57	1.299	33	
3/8	0.984	25.0	0.305	7.75	1.654	42	
1/2	0.984	25.0	0.370	9.4	1.732	44	
3/4	0.984	25.0	0.620	15.75	1.969	50	
1	1.988	50.5	0.870	22.1	2.283	58	
1 1/2	1.988	50.5	1.370	34.8	2.638	67	
2	2.520	64	1.870	47.5	3.071	78	
2 1/2	3.051	77.5	2.370	60.2	2.795	71	
3	3.583	91	2.870	72.9	3.169	80.5	

Temperature and Pressure Ratings

- Pressures up to 16 Bar (230 psi)
- Temperatures up to 120°C (250°F) with EPDM Gaskets
- Temperatures up to 180°C (356°F) with PTFE, Silicone or Viton Gaskets
- Higher Pressures and Temperatures with Special Clamps and Gaskets.

Internal Surface Finish Specifications

- ASME BPE SF3 (mechanical polish, not electropolished) Surface Finish, Maximum reading: <0.76µm Ra = <30µ in. Ra
- ASME BPE SF4 (mechanical polish and electropolished) Surface Finish, Maximum reading: <0.375µm Ra = <15µ in. Ra (SF4 is the highest level of surface finish specified in ASME BPE, and the standard, stocked fittings listed are all to this finish).
- DIN 32676 H4 (mechanical polish, not electropolished) Surface Finish, Average reading: <0.4µm Ra = <16µ in. Ra If the standard SF4 finish is not acceptable, H4 must be requested on the enquiry/order.

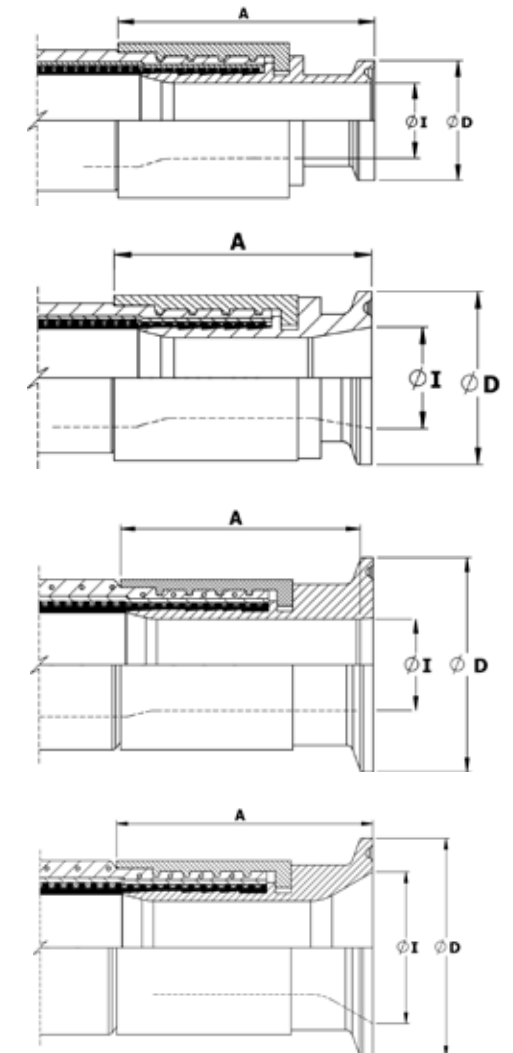

Mini-Sanitary Triclamp Fittings

Sanitary Triclamp Fittings

Corroline⁺ Sanitary Triclamp (Triclover) Fittings - Elbow

End Fitting Specifications

- BS4825 Pt 3
- ASME-BPE-a
- Others to Special Order

End Fitting Materials

- Fittings in Grade AISI 316L = EN 1.4404 = BS 316 S11
- Ferrules, most in Grade 304 SS, some sizes in Grade 316L SS

Surface Finish :

- The internal surface is to ASME BPE-SF-3 (<0.76 µm Ra, not electropolished).
- If a specified finish on a particular surface is required, please state on the enquiry and order.

Outlet Diameters

The outlet diameters as listed are in accordance with BS4825. The ASME specification, however, requires these diameters to be 0.005" (0.125mm) less in each case. An Outlet Diameter tolerance of +0.000 -0.005" has therefore been applied, so that the same fitting satisfies requirements of both specifications.

Temperature and Pressure Ratings

- Pressures up to 16 Bar (230 psi)
- Temperatures up to 120°C (250°F) with EPDM Gaskets
- Temperatures up to 180°C (356°F) with PTFE, Silicone or Viton Gaskets
- Higher Pressures and Temperatures with Special Clamps and Gaskets.



Non-Lined Sanitary Triclamp 90° Elbow Fitting (Table 1)

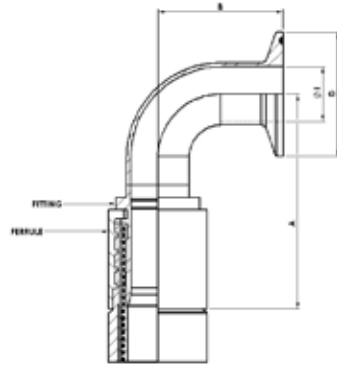

Non-Lined Sanitary Triclamp 45° Elbow Fitting (Table 2)

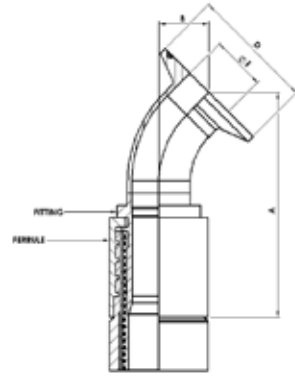

Nominal Hose Size		*Centre Line to Fitting End A		Centre Line to Face B		Flange Diameter D		Outlet Diameter I		Weight of Fitting	
in	mm	in	mm	in	mm	in	mm	in	mm	Kg	Lbs
1/2	13	2.91	74	0.71	17.96	0.98	25.0	3/8	9.5	0.09	0.21
3/4	20	3.11	79	0.71	17.96	0.98	25.0	5/8	16.0	0.14	0.30
1	25	3.74	95	0.80	20.22	1.98	50.5	7/8	22.2	0.26	0.58
1 1/2	40	4.61	117	1.02	25.81	1.98	50.5	1 3/8	34.9	0.45	1.00
2	50	5.51	140	1.24	31.43	2.16	64.0	1 7/8	47.6	0.75	1.65
2 1/2	65	6.14	156	1.46	37.05	3.05	77.5	2.37	60.2	1.48	3.25
3	80	7.09	180	1.68	42.66	3.58	91.0	2.87	72.9	1.99	4.38

Nominal Hose Size		*Centre Line to Fitting End A		Centre Line to Face B		Flange Diameter D		Outlet Diameter I		Weight of Fitting	
in	mm	in	mm	in	mm	in	mm	in	mm	Kg	Lbs
1/2	13	2.83	72	1.61	41	0.98	25.0	3/8	9.5	0.09	0.21
3/4	20	3.23	82	1.61	41	0.98	25.0	5/8	16.0	0.14	0.30
1	25	3.62	92	2.01	51	1.98	50.5	7/8	22.2	0.26	0.58
1 1/2	40	4.72	120	2.76	70	1.98	50.5	1 3/8	34.9	0.45	1.00
2	50	5.91	150	3.50	88.9	2.16	64.0	1 7/8	47.6	0.75	1.65
2 1/2	65	5.43	138	4.25	108	3.05	77.5	2.37	60.2	1.48	3.25
3	80	7.76	197	5.00	127	3.58	91.0	2.87	72.9	1.99	4.38

Corroline⁺ DIN11851 Male and Female Fittings

End Fitting Materials

- Spigots in Grade 316L SS (Non-Lined Spigot in 1.4571*)
- Nuts in Grade 304 SS
- Ferrules, most in Grade 304 SS, some sizes in Grade 316L SS

*1.4571 is a special grade of 316 stainless steel, equivalent to AISI 316Ti

Surface Finish:

- All surface finishes are to ASME BPE-SF-3 > 0.76 µm Ra mechanical polish.
- If a specified finish on a particular surface is required, please state on the enquiry and order.

DIN11851 Female Fitting - Non Lined

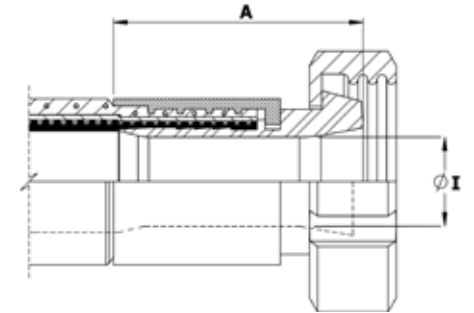

Nominal Hose Size		I Diameter		Fitting Length A		Weight of Fitting	
in	mm	in	mm	in	mm	Kg	Lbs
1/2	15	0.37	9.4	1.63	41.5	0.20	0.44
3/4	20	0.62	15.8	1.87	47.5	0.34	0.76
1	25	0.85	21.5	2.33	59.2	0.49	1.08
1 1/4	32	1.03	26.2	2.58	65.5	0.64	1.40
1 1/2	40	1.25	31.8	2.76	70.0	0.85	1.86
2	50	1.76	44.6	3.23	82.0	1.20	2.04
2 1/2	65	2.25	57.2	3.03	77.0	1.59	3.50
3	80	2.63	66.7	2.97	75.5	2.04	4.49

DIN11851 Male Fitting - Non Lined

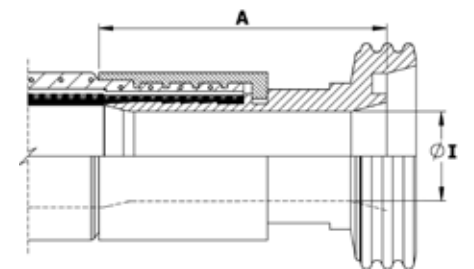

Nominal Hose Size		I Diameter		Fitting Length A		Weight of Fitting	
in	mm	in	mm	in	mm	Kg	Lbs
1/2	15	0.37	9.4	1.82	46	0.14	0.30
3/4	20	0.62	15.8	2.05	52	0.28	0.62
1	25	0.85	21.5	2.68	68	0.40	0.87
1 1/4	32	1.03	26.2	2.48	63	0.55	1.21
1 1/2	40	1.25	31.8	2.84	72	0.76	1.68
2	50	1.76	44.6	3.23	82	0.92	2.04
2 1/2	65	2.25	57.15	3.23	82	1.27	2.79
3	80	2.63	66.7	3.23	82	1.62	3.56

Corroline⁺ 37° JIC Female Fittings and NPT Male & Female Unions

37° JIC Female Fitting

End Fitting Specifications

- SAE J514 37° Flare JIC Female Fitting
- 37° JIC Male-to-NPT Male/Female Adaptors
- NPT Threads to ANSI/AMSE B1.20.1

Temperature and Pressure Ratings

- Same Maximum Working Pressure and Temperature as for the relevant size of Corroline⁺ Hose, on page 6.

Note: Not usable with SAE 45° Flare fittings which have the same thread.

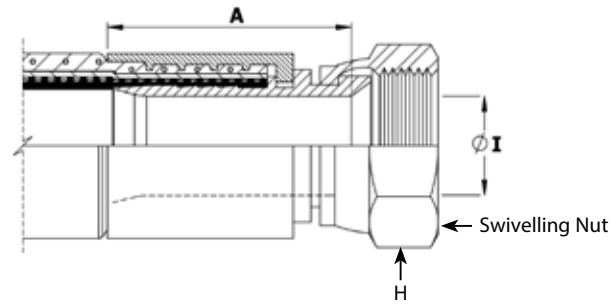

Nominal Hose Size		37° JIC Thread Size	*Fitting Length A		Hex Size H		Fitting Inner Diameter I		Weight of Fitting	
in	mm	in	in	mm	in	mm	in	mm	Kg	Lbs
1/2	13	3/4 - 16	1.57	40	0.88	22.2	0.37	9.40	0.09	0.20
3/4	20	1 1/16 - 12	1.89	48	1.25	31.7	0.62	15.75	0.20	0.44
1	25	1 5/16 - 12	2.28	58	1.50	38.1	0.85	21.50	0.30	0.66
1 1/2	40	1 7/8 - 12	2.72	69	2.25	57.1	1.25	31.75	0.62	1.37
2	50	2 1/2 - 12	3.27	83	2.88	73.0	1.76	44.60	1.10	2.42

JIC to NPT Male Union (including a JIC Male to NPT Male Adaptor)

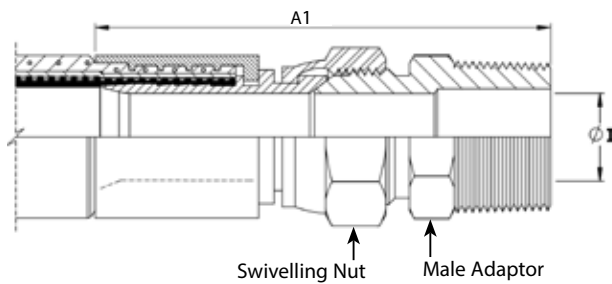

Nominal Hose Size		*Female Union Length A1		Fitting Inner Diameter I		Weight of Fitting	
in	mm	in	mm	in	mm	Kg	Lbs
1/2	13	3.07	78	0.53	13	0.15	0.33
3/4	20	3.78	96	0.72	18	0.33	0.73
1	25	4.17	106	0.94	24	0.51	1.12

JIC to NPT Female Union (including a JIC Male to NPT Female Adaptor)

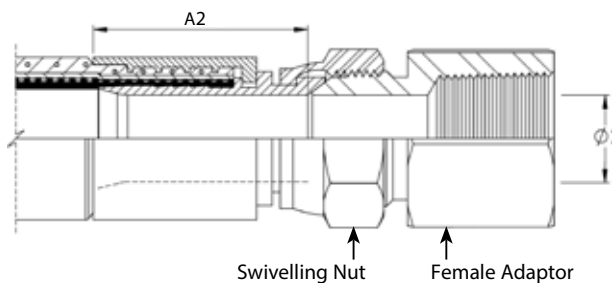

Nominal Hose Size		*Female Union Length A2		Fitting Inner Diameter I		Weight of Fitting	
in	mm	in	mm	in	mm	Kg	Lbs
1/2	13	3.07	78	0.39	9.9	0.17	0.37
3/4	20	3.78	96	0.61	16	0.34	0.75
1	25	4.17	106	0.84	21	0.64	1.41

Corroline⁺ NPT and BSPT Fixed Male & NPT Fixed Female Fittings

End Fitting Specifications

- NPT Taper Threads to American National Standard Pipe Taper Thread design to ANSI/AMSE B1.20.1.
 - BSPT Threads to British Standard Pipe Taper Thread design to BS21
- Alternatives - Parallel Threads, Metric Threads and Others.

End Fitting Materials

- Fittings in Grade 316L SS
- Ferrules, most in Grade 304 SS, some sizes in Grade 316L SS

- Available in other materials to special order
- Alternatives - Hydraulic design BSPT Male Fittings in Zinc Plated Carbon Steel, to special order.

Surface Finish :

- All surface finishes are to ASME BPE-SF-O (No finish required).
- If a specified finish on a particular surface is required, please state on the enquiry and order.

Fixed Male NPT or BSPT

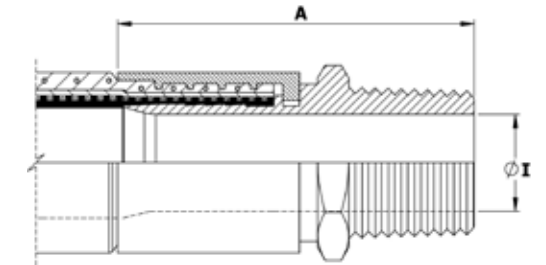

Nominal Hose Size		NPT or BSPT Thread Size	*Fitting Length A		Fitting Inside Diameter I		Weight of Fitting	
in	mm	in	in	mm	in	mm	Kg	Lbs
1/2	13	1/2	2.40	61	0.37	9.40	0.14	0.30
3/4	20	3/4	2.68	68	0.62	15.75	0.25	0.54
1	25	1	3.07	78	0.85	21.50	0.33	0.73
1 1/4	32	1 1/4	3.58	91	1.03	26.21	0.61	1.34
1 1/2	40	1 1/2	3.82	97	1.25	31.75	0.81	1.78
2	50	2	4.57	116	1.76	44.60	1.17	2.58
2 1/2	65	2 1/2	5.31	135	2.25	57.15	1.84	4.04
3	80	3	5.39	137	2.63	66.7	2.49	5.47

Fixed Female NPT

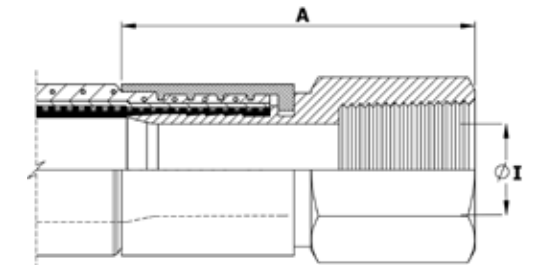

Nominal Hose Size		NPT Thread Size	*Fitting Length A		Fitting Inside Diameter I		Weight of Fitting	
in	mm	in	in	mm	in	mm	Kg	Lbs
1/2	13	1/2	2.40	61	0.37	9.40	0.18	0.39
3/4	20	3/4	2.52	64	0.62	15.75	0.24	0.54
1	25	1	3.23	82	0.85	21.50	0.37	0.81
1 1/2	40	1 1/2	3.62	92	1.25	31.75	0.83	1.82
2	50	2	4.13	105	1.76	44.60	1.24	2.72

Corroline⁺ BSP 60° Cone Seat Female Unions and Non-Lined Tube Adapter (Grooved Standpipe) Fittings

End Fitting Specifications

- BSPP Threads to British Standard Pipe Parallel Thread design to BS21, 60° Cone Seat design, or Flat Seat.

End Fitting Materials

- Spigots in Grade 316L SS
- Nuts in Grade 316L SS
- Ferrules, most in Grade 304 SS, some sizes in Grade 316L SS

BSP 60° Cone Seat Female Union Fitting



Alternatives:

- Hydraulic design Cone Seat Female Unions can be supplied in Zinc Plated Carbon Steel to special order.
- Lug Nuts can be supplied in Gun Metal (Bronze) if required.

Surface Finish :

- All surface finishes are to ASME BPE-SF-O (No finish required).
- If a specified finish on a particular surface is required, please state on the enquiry and order.

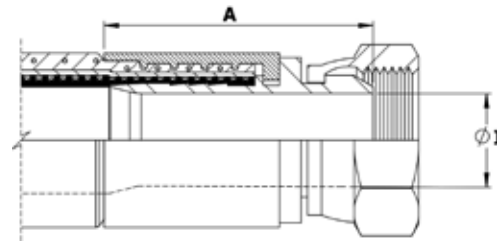

Nominal Hose Size		NPT or BSPT Thread Size		*Fitting Length A		Fitting Inside Diameter I		Weight of Fitting	
in	mm	in	mm	in	mm	in	mm	Kg	Lbs
1/2	13	1/2	1.46	37	0.37	9.40	0.09	0.21	
3/4	20	3/4	1.89	48	0.62	15.75	0.20	0.44	
1	25	1	2.17	55	0.85	21.50	0.33	0.72	
1 1/4	32	1 1/4	2.48	63	1.03	26.21	0.49	1.07	
1 1/2	40	1 1/2	2.87	73	1.25	31.75	0.79	1.73	
2	50	2	2.91	74	1.76	44.60	1.07	2.36	
2 1/2	65	2 1/2	3.15	80	2.25	57.15	1.37	3.02	
3	80	3	3.21	81.5	2.63	66.7	2.10	4.62	

Non-Lined Tube Adapter (Grooved Standpipe) Fitting

End Fitting Specifications

- Compatible with existing Industrial Standard Tube Fitting Components.

End Fitting Materials

- Fitting in grade 316L SS
- Ferrule (for hose attachment) in Grade 304 or 316L SS

Alternatives can be supplied with matching Female nuts & Ferrules (clamping Ferrules) to suit.

Surface Finish:

- All surface finishes are to ASME BPE-SF-O (No finish required).
- If a specified finish on a particular surface is required, please state on the enquiry and order.

Temperature & Pressure Ratings

- As for the relevant size of hose on Page 6.

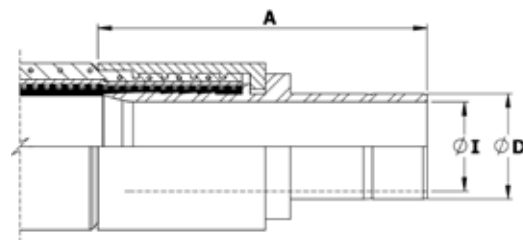

Nominal Hose Size		Fitting Length A		Diameter D		Fitting Inside Diameter I		Weight of Fitting	
in	mm	in	mm	in	mm	in	mm	Kgs	Lbs
3/4	20	2.48	63	3/4	19.05	0.62	15.75	0.16	0.35
1	25	2.87	73	1	25.40	0.85	21.50	0.25	0.55

Corroline⁺ Dip Pipes, Straight or 90° Elbow

Fixed Dip Pipes

Description

Fixed Dip Pipes are fairly rigid, thick wall PTFE tubes, either straight or 90° elbowed, which are directly crimped to the end of Corroline⁺ hoses. They are designed for insertion into drums, tanks and reaction vessels in order to suction drain (or inject) process fluids transferred through the hose.

Materials

- Standard dip pipes are in anti-static (AS) PTFE
- Ferrules, most in Grade 304 SS, some sizes in Grade 316L SS

How to order

Specify the size and material of the dip pipe, whether it is straight or 90° elbowed. Give the length of the straight leg of the dip pipe and the length of the rest of the hose assembly separately.

Maximum Working Pressures

Dip Pipes are normally only tested to 6 Bar Pressure, and are not suitable for use at pressures higher than 3 Bar. They are usable at negative pressure up to -0.9bar vacuum.

If higher pressure ratings are required, consult Aflex Hose.

Lengths

Dip Pipes are supplied as standard in 1 metre straight lengths, but can be supplied in any length to individual requirements.

Note: Not available as a Hydraulic Fitting.

Fixed Dip Pipe (90° Elbow)



Fixed Dip Pipe (Straight)

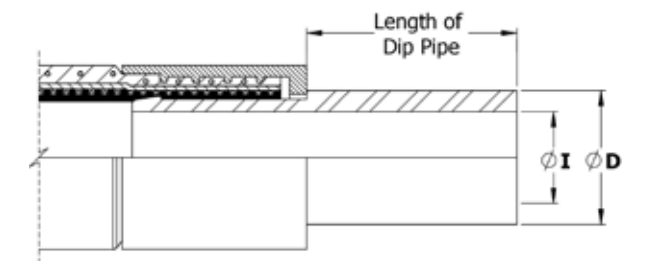

Nominal Hose Bore Size	Approximate Dip Pipe Dimensions				
	Outside Diameter D		Inside Diameter I		
in	mm	in	mm	in	mm
3/4	20	0.87	22	0.51	13
1	25	1.14	29	0.83	21
1 1/2	40	1.54	39	1.00	27
2	50	2.17	55	1.58	40

Detachable Dip Pipes

Description

As Fixed Dip Pipes above, but connected to the hose through an end fitting, not by crimping direct to the hose.

Design

A straight, or 90° elbowed anti-static PTFE Dip Pipe, fitted with a Flange or Cam & Groove Male PTFE Lined & Flared end fitting.

The most usual end fitting is a Cam Male (as shown), so the dip pipe can then be connected to a hose with a Cam Female end fitting.

Specifications

As above for Fixed Dip Pipes

Detachable Dip Pipe

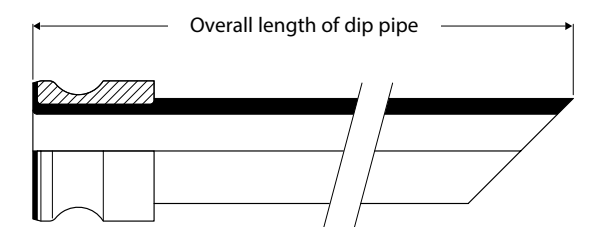

Standard Labelling



All Corroline⁺ hose assemblies are labelled with the following information:

Manufacturer's Name (Aflex Hose Ltd)

Hose Size and Grade

EN16643 and year of standard publication

EN16643 Electrical Property Grade

Max. Working Pressure and Test Pressure

Working Temperature Range

Unique Serial Number

Month & Year of Manufacture

Aflex Hose Telephone Number

CE Mark (if applicable)

This information is normally laser-etched on to the ferrule.

In some cases, at the discretion of Aflex Hose, the information may be etched on to a thin stainless steel plate which is clamped to the hose, or a loose stainless steel ring mounted on the hose. This may be necessary for example, if the customer requires additional information which may not fit on to the ferrule.

Customers may specify which labelling system they require, and may request additional information on the label.

Colour Coding



A coloured PTFE spiral strip is wound on to the hose.

It can be left loose, or it can be encapsulated under a transparent, heat-shrunk polyolefin sleeve.

Cleaning & Sterilising Systems - CIP, SIP and Autoclave

CIP & SIP – PTFE liner tubes are chemically resistant to all CIP, SIP and Autoclave conditions. A primary consideration is whether the cleaning and purging cycle is likely to develop an electrostatic charge on the internal surface of the liner, in which case AS (Anti-Static) grade hose is required.

AS grade hose and Electrostatic charge generating systems are fully described in the hose liner section.

CIP systems using high electrical resistivity solvents like Toluene will require AS grade hose.

Another electrostatic generation problem arises when wet steam is passed through, or when the cleaning fluids or WFI are purged out of the line using nitrogen, compressed air or another gas, because droplets of liquid or water in the gas then generate a multi-phase condition until they are cleared out, which will generate a static charge, and so will require AS grade hose.

Autoclave

Corroline⁺ hose is able to withstand at least 100 x 30 minute autoclave cycles at relatively high autoclave temperatures (upto 135°C, 275°F). Consult Aflex Hose for more specific information.

PTFE Hose-Use with Alkali Metals, Halogens and certain Halogens containing Chemicals

PTFE hose liners react chemically with Fluorine, Chlorine Trifluoride and molten Alkali Metals and so no hose grades are suitable for use with these chemicals.

When PTFE lined hose is used to carry Chlorine or Bromine, either as gasses or fluids, trace quantities can diffuse into and through the PTFE liner wall thickness. These will then combine with atmospheric moisture to corrode the SS braid or rubber cover outside the liner tube. It has been found that Corroflon SP, HB or KYB hose is best suited for these applications - Please consult the Corroflon brochure.

Depending upon the internal pressures and temperatures, some other gasses and fluids with a high halogen content may also be transmitted in trace quantities through the wall of the PTFE tube, including Hydrogen Fluoride, Hydrogen Chloride, Carbonyl Chloride (Phosgene), Carbon Tetrachloride and others. Please consult with Aflex Hose for a suitable hose grade recommendation.

Other "Penetrating" Fluids and Gases

Sulphur Trioxide, Methyl Methacrylate, Caprolactam and Glacial Acetic Acid are some other chemicals which do not react chemically with the PTFE, but which can be absorbed and transmitted in trace quantities through the PTFE liner tube wall - please consult Aflex Hose for the optimum solution with these chemicals.

Generally, however, as a hydrophobic (non-wetting) material, PTFE is very resistant to the absorption of chemicals. In some cases, PTFE has superior resistance to diffusion, for example to the diffusion of automotive fuels, in comparison with all other plastics and rubbers.

Gas/Fluid Cycling

There are some applications where fluids then gasses are passed through the hose, in a cyclic sequence.

This is normally associated with changes in temperature and/or pressure. For complex reasons these conditions are extremely damaging to the hose liner, whatever material it is made from.

For example, hoses are sometimes used to pass steam, water, steam etc into rubber moulding presses, in order to heat the mould, then rapidly cool it before reheating in the next cycle. Hoses of all types fail rapidly in such an application and PTFE lined hoses are no exception.

Please contact Aflex Hose for further information if these conditions apply.

Connecting Assemblies for Use in Applications

The lengths of hose assemblies and their configuration in use when connected into the application must always be in accordance with the Hose Configuration information at the end of this product literature.

When being connected for use in applications, the end fittings on hose assemblies must be connected to correct mating parts in the correct way, using the correct tools, spanners, clamps, nuts and bolts etc. The connections must be sufficiently tightened to ensure that the joint is leak free but not be over tightened as this can damage the sealing surfaces, especially with PTFE lined and flared end fittings.

In applications involving the transfer through the hose of expensive or dangerous fluids or gases, the hoses and connections must be pressure tested in situ before being put in to service. This should be done with some harmless media to 1.5 times the maximum working pressure of the hose assembly, as stated in the product literature.

If in doubt please contact Aflex Hose for advice.

Special Applications

Aflex Hose PTFE lined hose products are not rated as suitable for use in the following, special applications:

- All Radioactive Applications involving high energy radiation, including Gamma radiation (degrades PTFE)
- All Medical Implantation Applications.

For Aerospace Applications, please contact Aflex for the appropriate hose choice.

Silicone-Free Application requirements

Some applications, particularly paint manufacturing plants, and other specialised applications require that hoses do not include any silicone containing materials in their manufacture, or sometimes that hoses are guaranteed to be 100% Silicone Free. Customers or Distributors must specifically identify and define any such requirements in writing on all enquiries/orders.

**Quality Assurance, Certification and Approvals,
and Hose Testing**

BS EN ISO 9001:2015

Aflex Hose Ltd are independently assessed and certified to BS EN ISO 9001 Quality Management System by The British Standards Institute (BSI).

EN 16643:2016

Corroline⁺ meets the requirements of EN 16643 (type SC), which include the electrical and electrostatic requirements of hose assemblies.

ISO 45001:2018

Aflex Hose Ltd have been successfully assessed to the requirements of ISO 45001, by the British Standards Institution (BSI). By gaining this accreditation Aflex Hose Ltd are demonstrating our commitment to the health and safety of our employees by consistently identifying and controlling risks to health and safety, reducing the potential for accidents, complying to relevant legislation and improving overall awareness throughout the business.

ISO 14001:2015

Aflex Hose Ltd have been successfully assessed to the requirements of ISO 14001, by the British Standards Institution (BSI). By gaining this accreditation Aflex Hose Ltd are demonstrating our commitment to reducing our impact on the environment.

FDA

The Materials used to manufacture the natural PTFE Tube liner conforms to FDA 21 CFR 177.1550, and the antistatic PTFE liner conforms to FDA 21 CFR 178.3297.

BPSA leachables and extractables testing

Aflex Hose Natural and Antistatic PTFE Hose Liner Tube has been independently tested in accordance with BPSA recommendations, and found to be satisfactory.

Copies of the Test Report are available for specific assessments to be made.

Flame Resistant

To special order only, Aflex Hose are able to supply hose with a special rubber cover which is compliant with the requirements of EN 45545, DIN 5510 and NFF 16101 specifications.

Pharmaceutical and Chemical Manufacturers Approvals

Most of the major pharmaceutical and Chemical manufacturing companies in the world have audited and/or approved Aflex Hose as a Hose Supplier.

CE Marking (Europe only)

Aflex has been assessed by The British Standards Institution (BSI) and found to comply with the Pressure Equipment Directive 2014/68/EU Conformity Assessment Module D1, approved to CE Mark applicable hose products, accompanied by a Hose Usage Data Sheet, and a Declaration of Conformity.

Attestations of Conformity to ATEX Directive 2014/34/EU (Potentially Explosive Atmospheres)

Available for hose assemblies for components used in Gas Zones 1 & 2 and Dust Zones 21 & 22, when applicable.

Material Certification to EN10204

Available for all the hose or hose assembly components.

Certificates of Conformity to BS EN ISO/IEC 17050

Are available for all products.

Hose Testing

Each assembly is pressure tested to 1.5 times maximum working pressure before despatch, and pressure test certificates can be supplied.

Fire Resistance to BS5173 Section 103.13 Part 6.2 and 6.3

RC Grade Corroline⁺ hose assemblies are "Fire Resistant". If DBK-300 is added at both ends, the assemblies are upgraded to "Fire Proof".

Food Contact

Manufactured in compliance with **Regulation (EC) No 1935/2004** - on materials and articles intended to come in to contact with food, **Commission regulation (EU) No 10/2011** - relating to plastic materials and articles intended to come into contact with food and **Regulation (EC) No 2023/2006** - on good manufacturing practise for materials and articles intended to come in to contact with food.

**Hose Configuration & Length Calculations
- for Bend Radius**

Hose Configuration Requirements

Hose Assemblies are usually connected at both ends in service. They may then either remain in a fixed, or static configuration or in a flexing, or dynamic configuration.

Whether static or dynamic, the First Rule concerning the configuration of the hose is that the bend radius of the hose must never be less than the Minimum Bend Radius (MBR) for the hose as listed in the relevant hose brochure.

The most common situation when this is likely to occur is when the hose is flexed at the end fitting, with stress being applied to the hose at an angle to the axis of the end fitting. Typically, this happens either because the length of the hose is too short, or because the weight of the hose plus contents creates a stress at an angle to the end fitting.

The Second Rule, therefore, if possible, is to design the configuration to ensure that any flexing in the hose takes place away from the end fittings.

(Dynamic) Configuration

INCORRECT - Hose too short

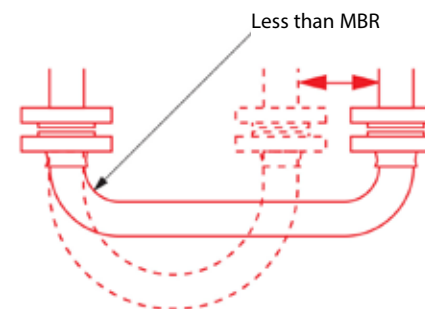

CORRECT - No flex at End Fittings

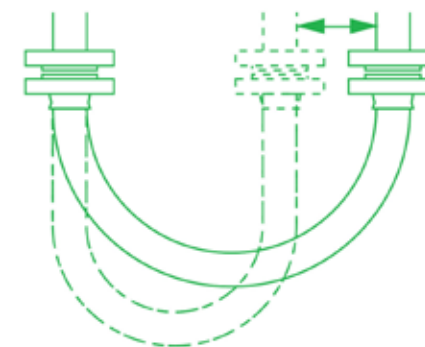

(Static) Configuration

INCORRECT - Weight of hose is at 90° to Axis of End Fittings

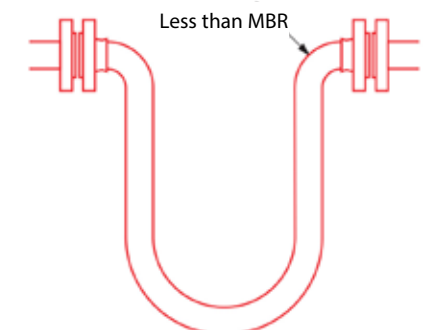

CORRECT - No flex at end fittings

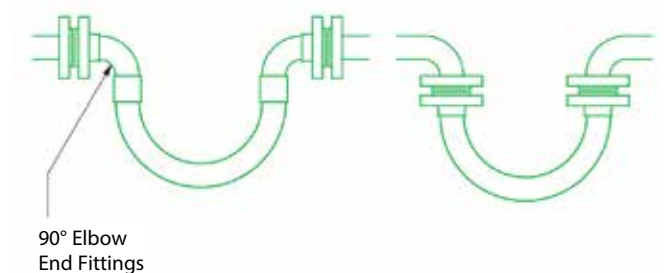

Hose Configuration & Length Calculations - for Abrasion & Torque

The Third Rule is that the hose configuration should always be designed, and supported where necessary, to avoid any possibility of external abrasion.

In some cases, the length, configuration and angle of the hose can be designed to avoid abrasion. In others, static or moving support frames or support wheels are required.

INCORRECT - Abrasion against hose

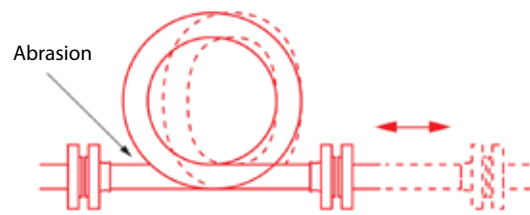

CORRECT - No hose abrasion

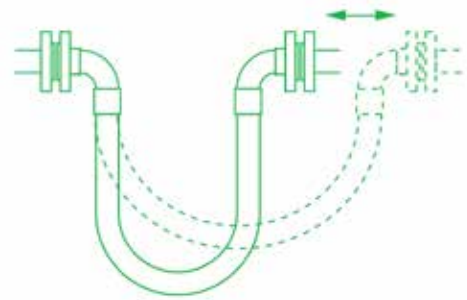

INCORRECT - Abrasion inside support

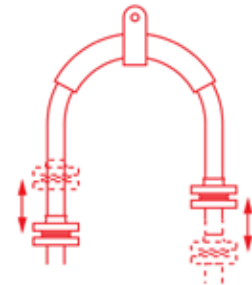

CORRECT - No abrasion over support

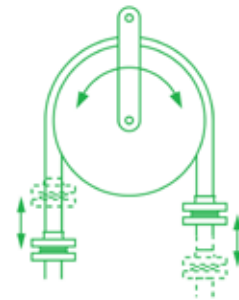

The Fourth Rule is that the hose must not be subjected to torque, either during connection, or as a result of the flexing cycle.

Torque (twist) in the hose can be applied during connection if the hose is accidentally twisted, or if the second end being connected is a screwed connection, and the hose is subjected to torque during final tightening.

In a flexing application, if any flexing cycle of the hose occurs in 3 dimensions instead of 2, then torque will also occur:

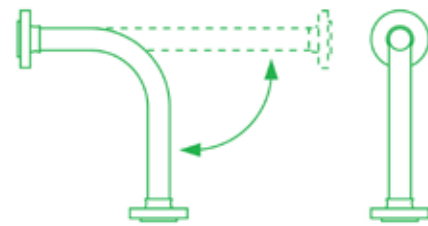

CORRECT - Flexing movement takes place in 2 dimensions

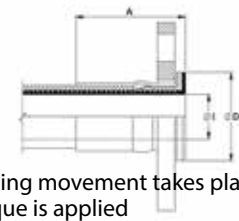
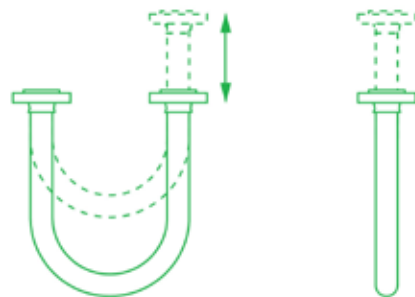

INCORRECT - Flexing movement takes place in 3 dimensions so torque is applied

Hose Configuration - for Length Calculation

Calculating the Hose Length

The formula for calculating the bent section of the hose length around a radius is derived from the basic formula that the circumference of a circle = $2\pi R$, where R = the radius of the circle, and π = a constant, = 3.142.

So, if the hose goes around a 90° bend, which is $\frac{1}{4}$ of a full circumference, and the radius of the bend is R , then the length of the hose around the bend is = $\frac{1}{4} \times 2\pi R$. Or half way round, in a U-shape, = $\frac{1}{2} \times 2\pi R$.

Note :

In calculating the length of a hose assembly, the (non-flexible) length of the end fittings must be added in, also the length of any straight sections of hose, as in the following example:

Example :

To calculate the length for a 2" bore size hose with flange end fittings, to be fitted in a 90° configuration with one leg 400mm long, the other 600mm long.

Length of Bent Section (yellow)	=	$\frac{1}{4} \times 2\pi R$ (334)
	=	$\frac{1}{4} \times 2 \times 3.142 \times 334 = 525\text{mm}$
Length of top, Straight Section, including the top end fitting length	=	$600 - 334 = 266\text{mm}$
Length of bottom end fitting	=	66mm
Total length of Hose Assembly	=	$525 + 266 + 66 = 857\text{mm}$

Things to consider

- A hose will normally take the longest radius available to it to go around a corner, not the MBR! Also - always remember to include the non-flexible end fitting lengths.
- In dynamic applications, remember to always calculate the lengths for the most extended configuration during the flexing cycle, not the least extended.
- If the configuration is simply too complex for calculation, then obtain a length of flexible tubing of some kind, mark on paper, or a wall, or floor, or both where the connection points will be relative to each other, scaled down if necessary, then manually run the flexible tubing between them with full radii round bends. Measure the extended length, then scale up if necessary to determine the approximate length of the hose.

If in doubt, consult Aflex Hose.

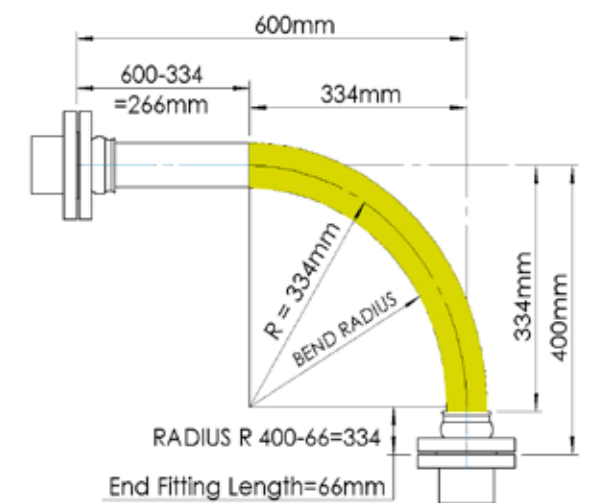
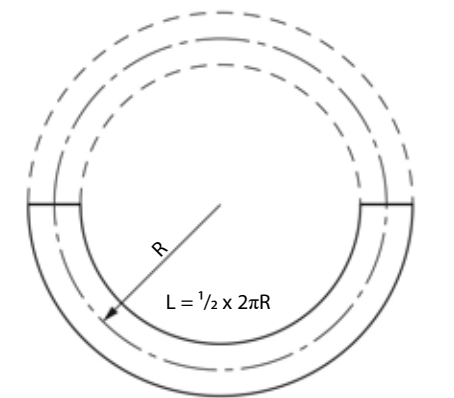
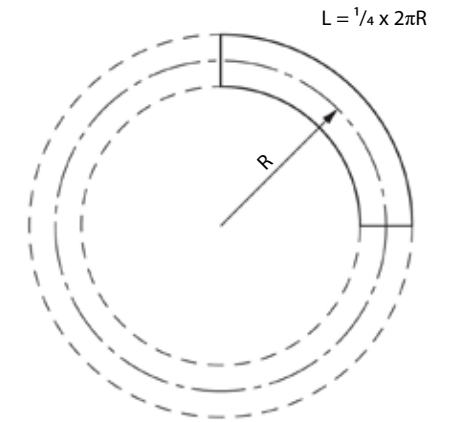

Note: The bend radius is measured to the inside edge of the hose, For the minimum bend radius refer to page 6.

Conditions of Sale

1. Definitions

“Business Days” means a day (other than a Saturday, Sunday or public holiday) when banks in London are open for business.

“Buyer” means a customer of the Seller.

“Conditions” means these terms and conditions for the sale of goods or the supply of services or both.

“Contract” means a binding contract for the sale of goods or the supply of services or both made by the Seller and the Buyer.

“Emergency Call-out” means the call-out service for emergency breakdowns of the Buyer’s plant or equipment provided by the Seller to the Buyer in accordance with these Conditions in connection with a Contract for the performance of the Services.

“Factored Products” shall mean products which are supplied by Seller, but are not manufactured by Seller, and are purchased by Seller from another supplier or manufacturer.

“Force Majeure Event” means an event beyond the reasonable control of the Seller including but not limited to strikes, lock-outs or other industrial disputes (whether involving the workforce of the Seller or any other party), failure of a utility service or transport network, act of God, epidemic or pandemic, war, riot, terrorism, civil commotion, malicious damage, compliance with any law or governmental order, rule, regulation or direction, accident, breakdown of plant or machinery, fire, flood, storm, default of suppliers or subcontractors.

“Goods” means the goods agreed to be sold by the Seller to the Buyer as detailed in the Order Acknowledgment.

“Intellectual Property Rights” means all copyright, database rights, semi-conductor topography rights, design rights, trademarks, trade names, patents, domain names and any other intellectual property rights of a similar nature (whether or not registered) subsisting anywhere in the world.

“Losses” means:

- (a) any indirect, special or consequential loss or damage; or
- (b) loss of data or other equipment or property; or
- (c) economic loss or damage; or
- (d) incurring of liability for loss or damage of any nature whatsoever suffered by third parties (including in each case incidental and punitive damages); or
- (e) any loss of actual or anticipated profit, interest, revenue, anticipated savings or business or damage to goodwill.

“Seller” means Aflex Hose Limited.

“Services” means the services agreed to be supplied by the Seller to the Buyer as detailed in the Order Acknowledgment.

“Specification for Goods” means the specification for the Goods that is agreed in writing by the Seller and the Buyer.

“Specification for Services” means the specification for the Services that is agreed in writing by the Seller and the Buyer.

2. Interpretation of Contracts

(a) The Uniform Law on International Sales, the United Nations Convention on Contracts for the International Sale of Goods and the international rules for the interpretation of trade terms prepared by the International Chamber of Commerce (INCOTERMS) shall be excluded. The construction, validity and performance of all Contracts shall be governed by English law and, without prejudice to the right of the Seller to take action against the Buyer in any other court of competent jurisdiction, any claim or dispute arising from the Contracts shall be subject to the exclusive jurisdiction of and be determined by the courts of England. The taking of proceedings in any one or more jurisdiction shall not preclude the Seller from taking proceedings in any other jurisdiction, whether concurrently or not, to the extent permitted by the law of such other jurisdiction.

(b) The complete or partial invalidity or unenforceability of any provision in a Contract shall in no way affect the validity or enforceability of the remaining provisions in a Contract. Any such provision shall be deemed to be modified to the minimum extent necessary to make it valid or enforceable. If such modification is not possible, the relevant provision shall be deemed severed subject to such consequential modification as may be necessary for the purpose of such severance.

(c) The headings used herein are for convenience only and shall not affect construction.

(d) Words in the singular include the plural and in the plural include the singular.

(e) Reference to a Condition is to a Condition of these Conditions unless the context requires otherwise.

3. Formation of Contracts and Application of Terms and Conditions

(a) All Contracts shall be deemed to incorporate these Conditions.

(b) Any variation to these Conditions shall have no effect unless expressly agreed in writing and signed by an authorised signatory of the Seller and any variation of a Contract shall have no effect unless it is in writing and signed by the Seller and the Buyer (or their authorised representatives).

(c) A prospective Buyer shall place its order for goods or services (or both) by completing the Seller’s purchase order standard form, if applicable, or by submitting its own purchase order form (in either case, such form is the “Purchase Order”). Each Purchase Order shall be deemed to be an offer by the prospective Buyer to buy the goods or services (or both) of the Seller that are identified in the Purchase Order subject to these Conditions.

(d) The Purchase Order shall only be deemed to be accepted when the Seller issues to the prospective Buyer an order acknowledgement form which indicates acceptance of the prospective Buyer’s offer on these Conditions (the “Order Acknowledgment”). A Contract between the Seller and the Buyer shall come into existence at the time and on the date when the Seller delivers the relevant goods or services (or both) to the Buyer.

(e) The Contract shall constitute the entire agreement between the Seller and the Buyer and the Buyer acknowledges that it has not relied on any statement, promise or representation made or given by or on behalf of the Seller that is not set out in the Contract.

(f) The Buyer shall ensure that the description of the goods or services (or both) ordered which is contained in its Purchase Order and any applicable specifications is complete and accurate.

(g) These Conditions apply to the Contract to the exclusion of all other terms and conditions that the Buyer shall seek to impose or incorporate, or which are implied by trade, custom, practice or course of dealing. These Conditions may be extended by additional terms and conditions issued by the Seller in writing and confirmed in the Order Acknowledgment.

4. Quotations and Purchase Orders

(a) Any quotation issued by the Seller shall not constitute an offer and is given on the basis that no Contract shall come into existence unless and until the Seller despatches an Order Acknowledgement to the Buyer.

(b) Any quotation issued by the Seller is valid for a period of 5 Business Days for delivery dates and 30 Business Days for prices only after the date of its issue, provided that the Seller has not previously withdrawn it by notice in writing to the Buyer.

(c) Subject to Condition 4(d), any Purchase Order accepted by the Seller shall be accepted on the basis that the price for the goods or services (or both) shall be that set out in the Seller’s quotation on condition that the Seller’s quotation is within its period of validity and notice of withdrawal in writing has not been issued by the Seller at the time of acceptance.

(d) The Seller reserves the right to give in writing notice of the withdrawal of a quotation at any time within the period of validity of the quotation and before the Contract is formed. In the event that the Seller changes the price of any of the goods or services (or both) offered for sale or supply, any existing quotation in respect of those goods or services (or both) shall be deemed to be automatically withdrawn and the Seller shall issue a new quotation to the prospective Buyer.

(e) The prices stated in the Seller’s quotations are exclusive of VAT.

(f) All Purchase Orders placed by a prospective Buyer shall be placed by fax, post or e-mail, or, where agreed in advance in writing by the Seller, by telephone or Seller’s electronic system for prospective Buyers to place orders and make payments.

SALE OF GOODS

5. The Goods

(a) The Goods are described in the Specification for Goods. The Goods shall comply with the Specification for Goods in material respects. Any stated dimension or weight set out in the Specification for Goods is an estimate only.

(b) All performance figures, descriptions (other than any description set out in the Specification for Goods), drawings and samples of Goods are approximate only being intended to serve merely as a guide. The Seller shall not be liable for their accuracy and they shall not form part of the Contract. No Contract shall be a contract by sample.

(c) The Seller may alter the Specification for Goods:

- (i) for the purpose of making changes to the Goods which it can establish to the reasonable satisfaction of the Buyer constitute improvements to the Goods or;
- (ii) if required by any applicable statutory or regulatory requirements.

(d) The Seller may increase the price of the Goods by giving notice in writing to the Buyer at any time before delivery, to reflect any increase in the cost of the Goods to the Seller that is due to:

Conditions of Sale continued

(i) any factor beyond the control of the Seller (including foreign exchange fluctuations, increases in taxes and duties, and increases in the cost of acquiring or manufacturing the Goods;

(ii) any request by a Buyer to change the delivery date(s), quantities or types of Goods ordered, or the Specification for Goods; or

(iii) any delay caused by any instructions of the Buyer in respect of the Goods or failure by the Buyer to give the Seller adequate or accurate information or instructions in respect of the Goods.

(e) All drawings, designs, and quotations for which goods are not subsequently ordered by the Buyer shall remain the property of the Seller and be treated as confidential by the Buyer and not used in any way. The Seller shall have no liability in relation to any such drawings, designs or quotation.

(h) The Buyer accepts that Seller is not an expert in the technical features which apply to Factored Products and/or their use in application. Seller’s only obligation will be to pass on to the Buyer all the written information which Seller has itself received regarding the Factored Product, but the Buyer shall be responsible for ensuring that this and any other necessary Factored Product information is obtained and is reviewed and will decide solely if such data is sufficient to ensure that the Factored Product is fit for purpose in the intended usage application. If any application requirements apply which are not fully covered by the information which the Buyer can obtain, then the Buyer undertakes not to use or supply the Factored Product for use in that application. The Buyer is also responsible for ensuring that the Factored Product will not be subjected to levels of usual or accidental physical abuse in service which would cause the Factored Product to fail. The Buyer agrees and acknowledges that Seller, its officers, directors, employees, affiliates and representatives shall not be held liable for any claims or obligations arising out of the Buyer’s failure to fulfil any or all of its responsibilities set forth in this clause 8(h), and hereby agrees to indemnify and hold Seller its officers, directors, employees, affiliates and representatives fully harmless from any and all claims that may arise in regard to Factored Products. If the Buyer has any doubts concerning these or any other usage conditions and limitation or safety parameters, the Buyer shall consult Seller and request a written response to any queries.

5A. UNTESTED HOSE SUPPLIES FOR SELF-ASSEMBLY BY BUYERS (“SAC”)

(a) Unless otherwise specified in writing by Seller, “loose” hose supplied (without end fittings attached) for self-assembly by Buyer (who will cut the hose to length and attach end fittings to make up Hose Assemblies for their own use, or for sale to their own customers) will not be pressure tested by Seller before supply. Such hydrostatic testing of the hose and the end fitting attachment will be the sole responsibility of the Buyer and Buyer warrants and represents that it shall carry out such hydrostatic pressure testing on all of its SAC hoses purchased from Seller, adhering to the maximum working pressure (MWP) and safety factor of the hose assembly as specified in the relevant Seller product brochure (as may be amended from time to time).

(b) When pressure testing braided hoses with a plastic or rubber outer cover, the cover will mask any signs of leakage for a time. The Buyer agrees and acknowledges that in respect of all SAC hoses, after the hydrostatic pressure test, it is further required to test each covered hose assembly with an internal helium gas pressure of 30 Bar (450 psi) for hose sizes up to 1” and 15 Bar (225 psi) for hose sizes above 1”, with the hose assembly immersed in water to enable leak detection by gas bubbles, for a minimum test period of 5 minutes.

(c) The Buyer agrees and acknowledges that in respect of all SAC hoses, Buyer alone shall determine and approve the design suitability of the hose assembly for its intended use before supply by Seller and that it shall indemnify and hold Seller fully harmless from any and all claims and losses, whether direct or indirect arising from design suitability for a SAC hose.

5B. UNTESTED HOSE ASSEMBLIES

If Seller agrees under a Purchase Order to attach non-standard end fittings to hose assemblies which the Buyer supplies to Seller, Buyer acknowledges and agrees that, in some instances, it is not possible to connect such non-standard fittings to the Seller pressure testing system. In such cases Buyer agrees that Seller shall be entitled, on giving notice to Buyer, not to test such Goods. Seller shall label the hose assembly with a warning that it requires pressure testing before use. The Buyer agrees and acknowledges that Seller shall have no liability whatsoever if the Buyer does not comply with the warning that requires pressure testing before use, and agrees to fully indemnify and hold Seller fully harmless from any and all claims arising from any use by Buyer or onward sale by Buyer of such untested hose assemblies.

6. Despatch and Delivery

(a) For the purposes of this Condition 6, the “Goods” shall mean the Goods in their entirety where delivery is not by instalments or, where delivery is by instalments, each instalment of the Goods.

(b) Unless otherwise agreed in writing by the Seller, delivery of the Goods shall take place at the location stated by the Seller in the Order Acknowledgment (the “Point of Delivery”).

(c) Any stated delivery date is an estimate and time for delivery shall not be of the essence. The Seller will use reasonable endeavours to meet any stated delivery date.

If no date for delivery is specified, delivery shall be within a reasonable time.

(d) THE SELLER SHALL NOT BE LIABLE FOR ANY LOSSES (AS DEFINED), CAUSED DIRECTLY OR INDIRECTLY BY ANY DELAY IN THE DELIVERY OF THE GOODS EVEN IF CAUSED BY THE SELLER’S NEGLIGENCE.

(e) ANY DELAY IN THE DELIVERY OF THE GOODS SHALL NOT ENTITLE THE BUYER TO TERMINATE OR RESCIND THE CONTRACT UNLESS SUCH DELAY EXCEEDS ONE HUNDRED AND EIGHTY (180) DAYS.

(f) Delivery of the Goods shall be completed on the arrival of the Goods at the Point of Delivery. Risk in the Goods shall pass to the Buyer on completion of delivery of the Goods.

(g) Except insofar as the Contract expressly provides otherwise, standard carriage and packaging is excluded in the price. Seller may select the method of delivery, and charge the Buyer for the cost of carriage. . Where the Goods are to be delivered at the Buyer’s request by any special or express means, the Seller will charge the Buyer the full cost of carriage. When any special packaging is required (whether at the Buyer’s request or because the Seller considers special packaging to be necessary), then the Seller will charge the Buyer the full cost of such packaging.

(h) In contracting for carriage and/or insurance of the Goods in transit, if required by the Contract, the Seller shall be deemed to act solely as agent of the Buyer.

(i) The Buyer must:

- (i) examine the Goods on delivery;
- (ii) notify the Seller and any carrier in writing of any shortage or damage within four (4) Business Days after the date of delivery and in respect of non-delivery within ten (10) Business Days after the Goods would in the ordinary course of events have been received; and
- (iii) in the case of short or damaged delivery give the Seller a reasonable opportunity to inspect the Goods,

otherwise Goods shall be deemed accepted by the Buyer.

(j) ANY LIABILITY OF THE SELLER FOR NON-DELIVERY OF THE GOODS SHALL BE LIMITED TO EITHER DELIVERING THE GOODS WITHIN A REASONABLE TIME OR ISSUING A CREDIT NOTE AT THE PRO RATA CONTRACT RATE AGAINST ANY INVOICE RAISED FOR SUCH GOODS.

(k) The Seller may deliver the Goods by instalments, each instalment to be deemed to be a separate Contract. Without limiting the other provisions herein, no failure or defect in delivery in respect of any Contract or instalment shall entitle the Buyer to repudiate or cancel any other Contract or instalment.

(l) If for any reason the Buyer fails to accept delivery of any of the Goods within two (2) Business Days of the Seller giving notice to the Buyer that the Goods are ready, or the Seller is unable to deliver the Goods on time because the Buyer has not provided appropriate instructions, documents, licences or authorizations for the Goods when they are tendered by the Seller for delivery then, except where such failure is caused by a Force Majeure Event:

- (i) delivery of the Goods shall be deemed to have been completed at 9.00 am on the second (2nd) Business Day after the day on which the Seller notified the Buyer that the Goods were ready;
- (ii) risk in the Goods shall pass to the Buyer on completion of delivery; and
- (iii) the Seller may store the Goods until delivery takes place, whereupon the Buyer shall be liable for all related costs and expenses (including, without limitation, storage and insurance). The Buyer shall be responsible for all Losses incurred by the Seller where the Buyer fails to accept delivery of Goods.

(m) If ten (10) Business Days after the Seller giving notice to the Buyer that the Goods were ready the Buyer has not accepted delivery of the Goods, the Seller may resell or otherwise dispose of part or all of the Goods.

(n) Due to the nature of the production of PTFE hose, Seller reserves the right to call a Purchase Order for bulk hose complete in the following situations: (a) if a product is a standard Seller product (as listed in Seller’s product brochures) a figure of +10% of original order quantity can be supplied. If the product is a non-standard product and outside the Seller’s standard product range the figure of +/- 10% of the original order quantity can be supplied. Goods supplied within these parameters would result in the Purchase Order being complete and delivery satisfied.

7. Title

(a) The title in the Goods supplied shall not pass to the Buyer until receipt by the Seller in cleared funds of payment in full (including payment of any default interest) for:

- (i) the Goods; and
- (ii) any other goods or services that the Seller has supplied to the Buyer and in respect of which payment is due.

(b) Until the title in the Goods passes to the Buyer the Buyer shall:

- (i) be a bailee of the Goods;

Conditions of Sale continued

(ii) store the Goods separately from all other goods held by the Buyer so that the Goods remain readily identifiable as the Seller's property;

(iii) not remove, deface or obscure any identifying mark or packaging on or relating to the Goods;

(iv) not fix or annex the Goods to or merge the Goods with any part of the Buyer's premises, plant or equipment without the Seller's prior consent in writing;

(v) maintain the Goods in satisfactory condition;

(vi) keep the Goods insured between the passing of risk in the Goods and title to the Goods against all risks with a reputable insurer which has been approved by the Seller for their full price, and ensure that the Seller's interest in the Goods is noted on the insurance policy until title in the Goods passes to the Buyer. If the Buyer fails to insure the Goods the Seller may do so instead on behalf of the Buyer, who shall reimburse the Seller on demand. Until title in the Goods passes to the Buyer, the Buyer shall hold in trust for the Seller the policy and proceeds of insurance;

(vii) notify the Seller immediately if it becomes subject to any of the events listed in Conditions 21(a)(iv) to 21(a)(x);

(viii) give the Seller such information relating to the Goods as the Seller may require from time to time; and

(ix) not dispose of, charge or encumber the Goods or any interest in the Goods or purport to do so,

but the Buyer may resell the Goods to an independent third party on arm's length terms in the ordinary course of its business.

(c) If before title to the Goods passes to the Buyer the Buyer becomes subject to any of the events listed in Conditions 21(a)(iv) to 21(a)(x), or the Seller reasonably believes that any such event is about to happen and gives notice to the Buyer accordingly, then, provided that the Goods have not been resold, or irrevocably incorporated into another product, and without limiting any other right or remedy the Seller may have, the Seller may at any time require the Buyer to deliver up the Goods and, if the Buyer fails to do so promptly, the Seller may enter any premises of the Buyer or of any third party where the Goods are stored in order to recover them.

8. Warranty for Goods

(a) Subject to Condition 8(b), the Seller warrants that on delivery, and for a period of 24 months (12 months for all Hose Assemblies which are "ETH" ("Electrical Trace Heated") Grade or are Factored Products) from the date of delivery the Goods shall:

(i) conform with the Specification for Goods; and

(ii) be free from material defects in material or workmanship.

(b) In respect of Goods which are packages or electrically or electronically controlled or actuated Goods, the Seller warrants that on delivery, and for a period of 12 months from the date of delivery such Goods shall:

(i) conform with the Specification for Goods; and

(ii) be free from material defects in material or workmanship.

(c) Subject to the remainder of this Condition 8, the Seller warrants that if (i) the Buyer provides the Seller with written notification within forty-eight (48) hours of discovering a suspected defect, (ii) if requested by Seller (after Buyer has provided all relevant information requested by Seller in respect of the suspected defective Good(s)), the Buyer returns the Goods within the relevant warranty period for such Goods (as set out in either Condition 8(a) or 8(b)) and (iii) on the Seller's examination such Goods prove defective as to material or workmanship or as to compliance with the relevant Specification for Goods the Seller shall:

(i) give notice to the Buyer that such Goods prove defective as to material or workmanship or as to compliance with the relevant Specification for Goods; and

(ii) following giving notice thereof to the Buyer;

(aa) with respect to Goods which have been manufactured by the Seller, make good the defect without charge by (at the Seller's option) repairing the defective Goods, replacing defective components of the defective Goods, or replacing the defective Goods (in their entirety) as the Seller in its discretion considers appropriate; or

(bb) with respect to Goods which have been supplied, but not manufactured by the Seller, and to the extent that it is entitled to do so, assign or at its discretion use its reasonable endeavours otherwise to make available to the Buyer, at the Buyer's expense and on the basis of an indemnity (secured if appropriate) against all Losses that may be incurred by the Seller in relation thereto, the benefit of any obligations and warranties which relate to such defect which the Seller may be owed by the manufacturer and/or supplier of the Goods or any part or component thereof.

(d) The above warranties shall apply except where the defect in the Goods:

(i) has been caused wholly or partly by deterioration of the Goods which is necessarily incidental to the transit of the Goods;

(ii) has been caused while the Goods were at the Buyer's risk by:

(aa) wilful default or negligence by the Buyer or its employees, agents, consultants or subcontractors;

(bb) the occurrence of an accident;

(cc) failure by the Buyer to follow the Seller's instructions in relation to the storage, use, installation, commissioning or maintenance of the Goods;

(dd) failure by the Buyer to follow good trade practice;

(ee) the Buyer altering or repairing such Goods without the consent in writing of the Seller;

(ff) fair wear and tear, negligence or by any abnormal conditions.

(e) Except as provided in this Condition 8, the Seller shall have no liability to the Buyer in respect of the Goods' failure to comply with the warranties set out in this Condition 8.

(f) The terms of these Conditions shall apply to any repaired or replacement Goods supplied by the Seller under Condition 8(c).

(g) The above warranties shall not apply to consumable items with a limited life expectancy.

9. Returns

(a) The Seller shall not refund the Buyer for any amounts paid by the Buyer in the event that the Buyer returns the Goods (or part thereof) except with the Seller's prior consent in writing. Where such consent is given, the Buyer agrees to pay to the Seller a minimum handling charge of thirty per cent (30%) of the invoiced value.

(b) To qualify for any refund, the Goods must be appropriately packed to protect them from being damaged in transit and be received by the Seller in a saleable condition within twenty-two (22) Business Days of delivery to the Buyer. The term "Goods" within this Condition 9(b) has the meaning set out within Condition 6(a).

10. Instructions and Health and Safety at Work

(a) The Buyer shall observe strictly the provisions of the Seller's instructions in writing regarding use and application of the Goods together with any revisions thereof and shall ensure that any person other than the Buyer who acquires or has access to the Goods is furnished with and observes such instructions.

(b) The Buyer shall be solely responsible for and shall keep the Seller indemnified against all Losses incurred by the Seller in relation to any use of the Goods other than in strict accordance with the Seller's installation, operating, and maintenance instructions.

(c) The Buyer agrees and acknowledges that for any intended application of the Good(s) in which special conditions apply which are not defined, or not defined sufficiently in the Seller's product brochure, the Buyer shall write to Seller requesting written advice relating to any usage limitations resulting from its special uses or conditions. The Buyer shall be fully liable and responsible for ensuring the design suitability and safety of the Goods in their intended applications, giving particular consideration to any special condition relating to, but not restricted to the chemical and electrostatic compatibility of the fluids or gases passing through, the possibility of diffusion of fluid or gases through the PTFE hose lining, the possibility of external corrosive conditions, the types and likelihood of excessive mechanical abuse, such as abrasion (internal or external), crushing, excessive flexing or vibrations, etc. and any excessive temperature and/or pressure "pulsing" conditions, or any other condition which may cause premature hose failure. The Buyer shall consider and take account of the degree of risk involved in any potential Goods failure, including the provision of adequate protection in the event of any risk to any persons. In applications where any type of Goods failure would lead to financial losses if the Goods are not replaced immediately, the Buyer agrees and acknowledges that it shall be the Buyer's responsibility to order and hold in stock spare Goods accordingly. The Buyer shall advise Seller in writing at the time of placing the enquiry and on any Purchase Order if there are any special requirements for the Good(s), including special cleaning, or drying, or extra testing requirements which are in addition to normal industrial standards. Mere notice of such additional requirements to Seller however, does not relieve the Buyer of its responsibility and liability for ensuring adequate measures are taken or are in place for such applications nor does the mere notification burden nor transfer to Seller any Buyers' liability that the Buyer has for such intended application.

11. Export Sales

(a) Where goods are supplied for export from England the following additional Conditions shall apply, and where there is any conflict between the provisions of this Condition 11 and any other Conditions, the provisions of this Condition 11 shall prevail.

(b) Charges for the cost of export deliveries and documentation shall be as stated in the Contract.

(c) Except where specifically agreed in writing to the contrary, delivery to a Buyer outside of the United Kingdom will be in accordance with the "Ex Works" rule from the international rules for the interpretation of trade terms prepared by the International Chamber of Commerce (INCOTERMS). In the case of deliveries outside of the United Kingdom the Seller does not accept any liability for damage to the Goods during transit, or marine or war risks unless otherwise specifically agreed by the Seller.

(d) The party which is exporting, in the case of exports, or the party which is importing, in the case of imports, will be responsible for obtaining all necessary licences, (or other governmental authorisations required in connection with any export, re-export, or imports, as the case may be, under the Contract. The parties will co-operate with each other in securing any such licenses or authorisations as may be required and each

Conditions of Sale continued

will provide such statements, certificates and assurances regarding transfer, use, disposition, end-use, source of supply, nationalities and re-export of the Goods as may be required in connection with each party's application for any required license or governmental authorisation.

(e) Any government fees or charges in connection with obtaining such licenses or authorisations will be the responsibility of the party which is exporting, in the case of exports, and the party which is importing, in the case of imports, the Goods.

(f) The Buyer undertakes not to:

(i) offer the Goods for resale in any country where the Buyer knows the export of the Goods is prohibited by the US Government, the UK Government, the UN, the EU or any other relevant organisation; or

(ii) offer to sell the Goods to any person the Buyer knows or suspects will subsequently resell the Goods into a country where export of the Goods is prohibited by the US Government, the UK Government, the UN, the EU or any other relevant organisation.

(g) The Buyer will indemnify the Seller for all liabilities, loss, damages, costs and expenses awarded against or incurred by the Seller arising out of in connection with any breach of the Buyer's obligations contained in Condition 11(g).

(h) The Buyer agrees to provide the Seller with any information the Seller reasonably requires concerning the destination and use of the Goods, to allow the Seller to comply in full with any relevant export legislation.

SUPPLY OF SERVICES

12. Period of Supply

(a) Unless otherwise specified in the Order Acknowledgment, the agreement for the supply of the Services shall be for a period of one (1) year from the date the Seller issues an Order Acknowledgement to the Buyer in accordance with Condition 3 (d) (the "Term for Services").

(b) The Seller reserves the right to increase its price for the Services at any time during the Term for Services. The Seller will give the Buyer notice in writing of any such increase not less than eight (8) weeks before the proposed date of the increase. If such increase is not acceptable to the Buyer, it shall notify the Seller in writing within two (2) weeks of the Seller's notice and the Seller shall have the right, without limiting its other rights or remedies, to terminate the Contract by giving four (4) weeks' notice in writing to the Buyer.

13. Performance of Services

(a) The Seller agrees to provide the Services in accordance with the Specification for Services in all material respects, and to supply as necessary spare or replacement parts and/or consumables, to the Buyer's plant and/or equipment at the sites(s) specified in the Seller's Order Acknowledgment.

(b) If the Seller agrees to supply spare or replacement parts and/or consumables, such supply will be strictly on the basis of these Conditions.

(c) Any stated performance date is an estimate only and time for performance of the Services shall not be of the essence. The Seller shall use reasonable endeavours to meet any stated performance date. If no date for performance is specified, the Services shall be performed within a reasonable time.

(d) **THE SELLER SHALL NOT BE LIABLE FOR ANY LOSSES (AS DEFINED), CAUSED DIRECTLY OR INDIRECTLY BY ANY DELAY IN THE PERFORMANCE OF THE SERVICES EVEN IF CAUSED BY THE SELLER'S NEGLIGENCE.**

(e) **SUBJECT TO CONDITION 13(G), ANY DELAY IN THE PERFORMANCE OF THE SERVICES SHALL NOT ENTITLE THE BUYER TO TERMINATE OR RESCIND THE CONTRACT UNLESS SUCH DELAY EXCEEDS ONE HUNDRED AND EIGHTY (180) DAYS.**

(f) **SUBJECT TO CONDITION 13(G), THE SELLER'S LIABILITY FOR NON-PERFORMANCE OF SERVICES SHALL BE LIMITED TO EITHER PERFORMING THE SERVICES WITHIN A REASONABLE TIME OR ISSUING A CREDIT NOTE AT THE PRO RATA CONTRACT RATE AGAINST ANY INVOICE SUBMITTED TO THE BUYER FOR THE SERVICES.**

(g) If the Seller's performance of the Services is prevented or delayed by the Buyer or by the failure of the Buyer to perform any of its obligations under the Contract ("Buyer Default") then upon the Seller giving the Buyer notice in writing that there has been a Buyer Default:

(i) the Seller shall without limiting its other rights or remedies have the right to suspend performance of the Services until the Buyer remedies the Buyer Default and to rely on the Buyer Default to relieve it from the performance of any of its obligations to the extent that the Buyer Default prevents or delays the Seller's performance of the Services;

(ii) the Seller shall not be liable for any Losses incurred by the Buyer arising directly or indirectly from the Seller's failure or delay in performing the Services; and

(iii) the Buyer shall reimburse the Seller on demand for all Losses incurred by the Seller arising directly or indirectly from the Buyer Default.

(h) The Seller reserves the right, at the Seller's discretion, to employ subcontractors to perform all or any part of the Services (including, without limitation, to commission, install, maintain or repair any parts or equipment) on behalf of the Seller.

(i) The Seller warrants that in providing the Services it will exercise reasonable care and attention and that it will comply with all applicable laws and regulations. However the Seller excludes liability for all Losses arising directly or indirectly out of any failure or diminution in performance of the Buyer's plant or equipment caused by the plant or equipment, or any part thereof:

(i) being used or operated otherwise than in accordance with any applicable installation, maintenance or operational instructions; or

(ii) being used or operated otherwise than in accordance with the Seller's instructions or recommendations; or

(iii) having been adjusted, changed or altered in any way by the Buyer or any third party since the date of installation or commissioning of the plant or equipment or the date of the immediately preceding visit by the Seller's employee or sub-contractor.

(j) The Buyer warrants to the Seller that the Buyer's plant and equipment is supplied with water at a quality that complies with BS2486 and is compliant with any additional requirements in writing notified by the Seller to the Buyer in respect of the Buyer's plant and equipment. The Seller excludes all liability for Losses arising directly or indirectly out of any failure or diminution in performance of the Buyer's plant or equipment or any part thereof which is caused directly or indirectly by a breach by the Buyer of this warranty.

(k) The Seller reserves the right to replace at the Buyer's cost the Buyer's plant or equipment or any part thereof which is unserviceable or inefficient as the Seller considers reasonably necessary in order to fulfil its obligations to provide the Services in accordance with the specification set out in the Order Acknowledgment.

(l) Alternatively, the Seller may charge the Buyer for the reconditioning of any part of the Buyer's plant or equipment that, in the reasonable opinion of the Seller, cannot be suitably or economically repaired on site. The Seller will provide the Buyer with an estimate of reconditioning charges for each item and if the Buyer does not agree to have the item(s) reconditioned, the Seller reserves the right to amend the scope of the Services as in its absolute discretion it considers necessary.

14. Access to Buyer's Site(s)

(a) The Buyer shall co-operate with the Seller in all matters relating to the Services, and shall provide the Seller with such information as the Seller may reasonably require in order to perform the Services. The Buyer shall ensure that such information is accurate in all material respects.

(b) The Buyer shall obtain and maintain any necessary licences, permissions, and consents which may be required before the date upon which the Services are due to start.

(c) The Buyer shall permit the Seller, its employees, agents, consultants and subcontractors full and free access to the Buyer's site(s) and to the Buyer's plant and equipment which is the subject of the Contract, subject to the Seller and its employees, agents, consultants and subcontractors complying with the Buyer's reasonable requirements as to site safety and security. If, at the time of any pre-arranged visit the Seller's employees, agents, consultants and subcontractors are unable to gain access to the Buyer's site(s) or plant or equipment in order to supply the Services, the Seller reserves the right to charge for the time spent attending at the Buyer's site(s) and for the cost of carrying out any subsequent visit.

(d) If reasonably required by the Seller, the Buyer shall make available to the Seller a secure storage area at the Buyer's site(s) for storage of the Seller's service equipment and shall keep all materials, equipment, documents and other property of the Seller (the "Seller Service Equipment") in such storage area in safe custody and at the Buyer's risk. The Buyer shall not dispose of the Seller Service Equipment other than in accordance with the Seller's instructions in writing.

(e) Prior to any visits by the Seller's employees, agents, consultants or subcontractors, the Buyer will:

(i) strip back any pipe lagging;

(ii) supply and erect suitable scaffolding (if required) to allow working access to the Buyer's plant and equipment; and

(iii) supply any necessary lifting equipment and required operators.

(f) Following any visits by the Seller's employees, agents, consultants or subcontractors, the Buyer will be responsible for the reinstatement of any pipe lagging and the dismantling of any scaffolding erected.

(g) The Buyer will provide the Seller's employees, agents, consultants and subcontractors with all specialist safety clothing or equipment as may be necessary to meet the Buyer's health and safety and environmental rules (excluding hard hat, safety glasses, overalls and protective shoes which will be provided by the Seller).

(h) The Buyer will procure that the Seller's employees, agents, consultants and subcontractors are covered by the Buyer's third party liability insurance policy of an amount of not less than three million pounds (£3,000,000) per occurrence whilst such employees or subcontractors are on the Buyer's site(s).

Conditions of Sale continued

(i) Emergency Call-outs are intended for genuine emergency breakdown of the Buyer's plant or equipment which is the subject of the Contract only and will be charged by the Seller to the Buyer at the appropriate daily rate specified in the Order Acknowledgment. Each Emergency Call-out will be charged as one (1) additional day of Services over and above the number of days specified in the Order Acknowledgment for the supply of the Services.

(j) The Buyer acknowledges and agrees that the Seller shall at no time own, occupy or control (or be deemed to control) any part of the Buyer's site(s) and/or hold or be fixed with any duties or liabilities under health and safety laws or regulations or common law in relation to any part of the Buyer's site(s).

GENERAL

15. Payment and Other Buyer Obligations

(a) In respect of the Goods, subject to Condition 15(d) the Seller shall invoice the Buyer for the full purchase price of the Goods on or at any time after the despatch of the Goods.

(b) In respect of the Services, the Seller shall invoice the Buyer for the Services either monthly or quarterly as set out in the Contract.

(c) In the event that the Buyer chooses to purchase additional Goods or Services from the Seller that are not set out in the Contract but which are related to the Contract, the terms of such Contract will be deemed to apply to such additional Goods or Services and the Seller will invoice the Buyer for such Goods and Services pursuant to Condition 15(a) or 15(b), as appropriate, under the original Purchase Order number unless otherwise agreed between the parties.

(d) The Seller may in its absolute discretion agree in writing to the Buyer paying for the Goods in instalments, or may agree in writing to extend credit to the Buyer in respect of the payment for Goods. In the event that the Seller agrees to payment by instalments or extends credit in respect of the payment by the Buyer for Goods, the Seller shall invoice the Buyer monthly for agreed instalments of the purchase price. The Seller may in its absolute discretion by notice in writing to the Buyer withdraw (with immediate effect) the Buyer's right to credit or to pay for the Goods by instalments.

(e) The Buyer shall pay each invoice submitted by the Seller:

(i) within the earlier of thirty (30) days of the date of the invoice or such other period of time after the date of the invoice as has been agreed in the Contract; and

(ii) in Sterling or such other currency as the Seller may from time to time agree in writing) to a bank account nominated in writing by the Seller.

(f) Time is of the essence in relation to payment.

(g) All amounts payable by the Buyer under the Contract are exclusive of VAT chargeable from time to time. Where any taxable supply for VAT purposes is made under the Contract by the Seller to the Buyer, the Buyer shall, on receipt of a valid VAT invoice from the Seller, pay to the Seller such additional amounts in respect of VAT as are chargeable on the supply of the Services or the Goods at the same time as payment is due for the supply of the Services or the Goods.

(h) The Buyer shall make all payments due under the Contract in full without any deduction whether by way of set-off, counterclaim, discount, abatement or otherwise unless required by law.

(i) No payment shall be deemed to have been received until the Seller has received cleared funds.

(j) All payments payable to the Seller under the Contract shall become due immediately on its termination despite any other provision.

(k) If the Buyer fails to pay the Seller any sum due pursuant to the Contract by the due date for payment:

(i) the Buyer shall be liable to pay interest to the Seller at the maximum rate allowed by applicable law; and

(ii) the Seller may, in its absolute discretion and without liability to the Buyer, suspend performance of its obligations under the Contract and under any or all other Contracts between the Seller and the Buyer or terminate the Contract and any or all other Contracts between the Seller and the Buyer with immediate effect.

(l) If the Buyer pays any amount to the Seller without apportioning it between specific debts or liabilities, the amount paid shall be apportioned as the Seller thinks fit. The Seller may attribute the entirety of an amount paid to one or more specific items in respect of which payment is due, rather than to all the items in respect of which payment is due.

(m) Buyer shall comply with all applicable laws, statutes, regulations and codes from time to time in force, including those related to data protection and to anti-bribery and corruption. Buyer must comply with the requirements of the United Kingdom Bribery Act 2010 (the "Act") and shall not engage in any activity, practice or conduct which would constitute an offence under sections 1, 2, or 6 of the Act if such activity, practice or conduct had been carried out in the United Kingdom. Additionally, Buyer shall comply, and shall ensure compliance of any party with which it subcontracts complies, with the requirements of the United Kingdom Modern Slavery Act (2015), including ensuring that all forms of forced labour are eliminated from its business.

16. Cancellation

(a) No contract shall be cancelled by the Buyer except with the Seller's prior consent in

writing.

(b) In the event of the Seller agreeing to the Buyer cancelling all or any part of the Contract, the Seller may, without prejudice to any other rights against the Buyer which it may have, require the Buyer to pay a cancellation charge. Any cancellation charge will correspond to the type of contract being cancelled. Contracts for bespoke Goods manufactured by the Seller to the Buyer's specifications may be subject to a cancellation charge of 100% of the price of the Contract after the Order Acknowledgment has been sent.

(c) In the event that the Seller agrees to cancellation of a Contract in respect of the supply of Goods or Services (or both) which have been ordered to comply with the Buyer's special requirements, the Buyer shall be liable for all costs incurred by the Seller up to the time of cancellation of the Contract in addition to payment of a cancellation charge pursuant to Condition 16(b).

17. Intellectual Property

(a) The Buyer acknowledges that:

(i) the Intellectual Property Rights in the Goods and any materials prepared by the Seller or on its behalf which relate to the Goods and their development (including, without limitation, drawings, designs, samples, models and similar items) (the "Goods Materials") are the Property of the Seller or the third party manufacturers of the Goods (as applicable);

(ii) nothing in these Conditions or in a Contract shall be construed as conferring any licence or granting any rights in favour of the Buyer in the Intellectual Property Rights in the Goods or the Goods Materials. The Buyer may re-sell the Goods subject to the Seller's right to control the use of its trade marks within the European Economic Area or jurisdiction into which the Goods are sold and the Buyer shall assist the Seller as required in preventing parallel importers from diluting the Seller's rights; and

(iii) any goodwill in any trade marks affixed or applied to the Goods shall enure to the sole benefit of the Seller or any other owner of the trade marks from time to time.

(b) The Buyer shall not repackage the Goods and shall not without the Seller's prior consent in writing allow any trade marks of the Seller or other words or marks applied to the Goods to be obliterated, obscured or omitted or add any additional marks or words.

(c) The Buyer shall not use (other than pursuant to these Conditions or a Contract) or seek to register any trade mark or trade name (including any company name) which is identical to, confusingly similar to, or incorporates any trade mark or trade name which the Seller owns or claims rights in anywhere in the world.

(d) If at any time it is alleged that the Goods infringe the rights of any third party or if, in the Seller's reasonable opinion, such an allegation is likely to be made, the Seller may at its option and its own cost:

(i) modify or replace the Goods in order to avoid the infringement; or

(ii) procure for the Buyer the right to continue using the Goods; or

(iii) repurchase the Goods at the price paid by the Buyer, less depreciation at the rate the Seller applies to its own equipment.

(e) The Buyer shall promptly notify the Seller of:

(i) any actual, threatened or suspected infringement of any of the Intellectual Property Rights in the Goods or the Goods Materials (or both) which comes to the Buyer's notice; and

(ii) any claim by any third party that comes to the Buyer's notice that the sale or advertisement of the Goods or the use of the Goods Materials (or both) infringes the rights of any person.

(f) The Buyer agrees (at the Seller's request and expense) to do all such things as may be reasonably required to assist the Seller in taking or resisting any proceedings in relation to any infringement or claim referred to in Condition 17(e), and the Buyer shall not make any admissions or statements in respect of or compromise any such claim other than with the prior written consent of the Seller.

(g) In the event of any claim, proceeding or suit by a third party against the Buyer alleging an infringement of such party's rights by any of the Intellectual Property Rights in the Goods or the Goods Materials (or both), the Seller shall defend the claim, proceeding or suit at the Seller's expense, subject to:

(i) the Buyer promptly notifying the Seller in writing of any such claim, proceeding or suit; and

(ii) the Seller being given sole control of the defence of the claim, proceeding or suit, and provided that the Seller shall not be liable and shall not defend the claim, proceeding or suit to the extent that such infringements arise out of or in connection with modifications to the Goods or the Goods Materials (or both) made by anyone except the Seller or its authorised representative, or out of use or annexation of the Goods or the Goods Materials (or both) with or to products or third party materials not specified or expressly approved in advance in writing by the Seller, or where the claim, proceeding or suit arises from the Seller's adherence to the Buyer's requested changes to the Specification for Goods or from infringing items of the Buyer's origin, design or selection.

(h) The Seller shall reimburse the Buyer with an amount equal to any liability assessed against the Buyer by final judgment on account of an infringement described in Condition 17 (g).

Conditions of Sale continued

(i) All Intellectual Property Rights in the or arising out of the or in connection with the Services shall be owned by the Seller.

(j) All Intellectual Property Rights in the materials, equipment, documents and other property of the Seller are the exclusive property of the Seller or of its licensors and shall be returned to the Seller on demand.

18. Trade Prohibitions

(a) The Buyer undertakes to the Seller that the Buyer shall not re-sell or otherwise supply the Goods to a third party which is the subject of any statutory trade prohibition of the United States of America or a member state of the European Union ("Sanctioned Third Party").

(b) Without prejudice to Condition 18(a), if the Seller shall have notice of or reasonable grounds to believe that the Buyer intends to re-sell or otherwise supply the Goods to a Sanctioned Third Party the Seller may upon giving notice thereof to the Buyer refuse to deliver the whole or any part of the Goods and shall have no liability to the Buyer for such refusal.

19. Limitation and Exclusion of Liabilities

(a) SUBJECT TO AND WITHOUT LIMITING CONDITION 19(B) OR ANY OTHER CONDITION, THE SELLER SHALL NOT BE LIABLE TO THE BUYER WHETHER IN CONTRACT, TORT (INCLUDING NEGLIGENCE), BREACH OF STATUTORY DUTY, OR OTHERWISE, FOR ANY LOSSES (AS DEFINED) ARISING DIRECTLY OR INDIRECTLY OUT OF OR IN CONNECTION WITH ANY CONTRACT FOR THE SUPPLY OF GOODS AND/OR SERVICES (OR THAT PART OF A CONTRACT WHICH RELATES TO GOODS AND/OR SERVICES).

(b) Notwithstanding any other terms of these Conditions the Seller does not limit or exclude its liability for fraud or fraudulent misrepresentation or for death or personal injury resulting from its negligence or the negligence of its employees, agents or subcontractors.

(c) SUBJECT TO AND WITHOUT LIMITING CONDITION 19(B) OR ANY OTHER CONDITION, THE SELLER'S TOTAL LIABILITY TO THE BUYER IN RESPECT OF ALL OTHER LOSS ARISING OUT OF OR IN CONNECTION WITH ANY CONTRACT FOR THE SUPPLY OF GOODS AND/OR SERVICES (OR THAT PART OF A CONTRACT WHICH RELATES TO GOODS AND/OR SERVICES), WHETHER IN CONTRACT, TORT (INCLUDING NEGLIGENCE), BREACH OF STATUTORY DUTY, OR OTHERWISE, SHALL IN NO CIRCUMSTANCES EXCEED THE VALUE OF THE CONTRACT WHICH GAVE RISE TO BUYER'S CLAIM.

(d) THE BUYER ACKNOWLEDGES AND AGREES THAT THE LIMITED WARRANTIES AND ALL LIMITATIONS AND EXCLUSIONS OF THE SELLER'S LIABILITY SET OUT IN THESE CONDITIONS ARE REASONABLE AND ARE REFLECTED IN THE PRICE OF THE GOODS OR SERVICES (OR BOTH) (AS APPLICABLE) AND THE BUYER SHALL ACCEPT RISK OR INSURE ACCORDINGLY (OR BOTH).

The Seller shall have no responsibility for any Losses incurred by the Buyer in the event that any information in any quotation or Order Acknowledgment is applied in connection with products other than the Goods and Services.

(f) This Condition 19 shall survive the termination or cancellation of the Contract.

20. Force Majeure

(a) The Seller shall not be liable to the Buyer as a result of any delay or failure to perform its obligations under the Contract as a result of a Force Majeure Event.

(b) If the Force Majeure Event prevents the Seller from providing any of the Services or Goods (or both) for more than forty-four (44) Business Days, the Seller shall, without limiting its other rights or remedies, have the right to terminate the Contract with the Buyer immediately by giving notice in writing to the Buyer.

21. Events of Default, Termination, Repossession, Suspension; Dispute Resolution

(a) The Seller may terminate the Contract with immediate effect by giving notice in writing to the Buyer if:

(i) the Buyer fails to pay any amounts due under the Contract on the due date for payment; or

(ii) the Buyer otherwise breaches the Contract with the Seller and the breach, if remediable and previously notified in writing to the Buyer, is not remedied within five (5) Business Days of the Buyer receiving such notice; or

(iii) the Seller terminates any other Contract between the Seller and the Buyer; or

(iv) the Buyer is or otherwise becomes insolvent or unable to pay its debts or suspends payment of its debts or threatens to do so or is unable to pay its debts as they fall due or admits its inability to pay its debts; or

(v) the Buyer commences negotiations with all or any class of its creditors with a view to rescheduling any of its debts, or makes a proposal for or enters into any compromise or arrangement with its creditors other than for the sole purpose of a scheme for a solvent amalgamation;

(vi) a petition is filed, a notice is given, a resolution is passed, or an order is made, for or in connection with the winding up of the Buyer other than for the sole purpose of a scheme for a solvent amalgamation;

(vii) a creditor or encumbrancer of the Buyer attaches or takes possession of, or a distress, execution, sequestration or other such process is levied or enforced on or

sued against, the whole or any part of its assets and such attachment or process is not discharged within fourteen (14) days;

(viii) an application is made to court, or an order is made, for the appointment of an administrator or if a notice of intention to appoint an administrator is given or if an administrator is appointed over the Buyer;

(ix) the holder of a qualifying charge over the assets of the Buyer has become entitled to appoint or has appointed an administrative receiver;

(x) a person becomes entitled to appoint a receiver over the assets of the Buyer or a receiver is appointed over the assets of the Buyer;

(xi) any event occurs, or proceeding is taken, with respect to the Buyer in any jurisdiction to which it is subject that has an effect equivalent or similar to any of the events mentioned in Conditions 21(a)(iv) to Condition 21(a)(x) (inclusive);

(xii) the Buyer suspends, threatens to suspend, ceases or threatens to cease to carry on, all or substantially the whole of its business;

(xiii) the Buyer's financial position deteriorates to such an extent that in the Seller's opinion the Buyer's capability to adequately fulfil its obligations under the Contract has been placed in jeopardy.

(b) In the event that the Seller terminates the Contract pursuant to Condition 21(a) the Seller may (in its absolute discretion and without prejudice to its other rights under these Conditions or otherwise) by notice in writing to the Buyer do any one or (to the extent not inconsistent with one another) more of the following:

(i) suspend any deliveries of Goods to be made under any contract with the Buyer;

(ii) revoke any express or implied authority to sell or use any Goods the title in which has not passed to the Buyer ("Relevant Goods");

(iii) require the Buyer to deliver to the Seller any Relevant Goods; and the Buyer shall do so, failing which the Seller may enter the premises where the Relevant Goods are or are thought to be and repossess the Goods, without liability for any resulting damage to the Buyer's premises, plant or equipment.

(c) All disputes arising out of or in connection with the Contract shall be submitted to the International Court of Arbitration of the International Chamber of Commerce and shall be finally settled under the Rules of Arbitration of the International Chamber of Commerce by one or more arbitrators appointed in accordance with the said Rules. The place of arbitration shall be London with the laws of England governing the Contract. The language of the arbitration shall be English.

22. Confidentiality

Each of the Seller and the Buyer (the "Receiving Party") shall keep in strict confidence all technical or commercial know-how, specifications, inventions, processes or initiatives which are of a confidential nature and have been disclosed to the Receiving Party by the other party ("Disclosing Party"), its employees, agents or subcontractors, and any other confidential information concerning the Disclosing Party's business, its products and services which the Receiving Party may obtain. The Receiving Party shall only disclose such confidential information to those of its employees, agents and subcontractors who need to know it for the purpose of discharging the Receiving Party's obligations under the Contract, and shall ensure

that such employees, agents and subcontractors comply with the obligations set out in this Condition 22 as though they were a party to the Contract. The Receiving Party may also disclose such of the Disclosing Party's confidential information as is required to be disclosed by law, any governmental or regulatory authority or by a court of competent jurisdiction. This Condition 22 shall survive termination or cancellation of the Contract.

23. Miscellaneous

(a) The Seller's rights under these Conditions are in addition to any other rights which the Seller may have under the general law or otherwise.

(b) If the Buyer comprises two or more persons, their obligations are joint and several.

(c) The Buyer shall not assign, transfer, mortgage, charge, sub-contract, or otherwise dispose of or deal in any Contract or any rights or obligations (or both) (as applicable) thereunder in whole or in part without the Seller's prior consent in writing. Any such action purported to be taken by the Buyer without the Seller's prior consent in writing shall be void.

(d) The Seller may at any time assign, transfer, mortgage, charge, sub-contract or otherwise dispose of or deal in its rights or obligations (or both) (as applicable) under any Contract or any part of it to any person, firm or company.

(e) A waiver by the Seller of any right under the Contract or law will only be effective if it is in writing. Any failure or delay by the Seller in exercising, or any partial exercise by the Seller, of any right or remedy under the Contract or by law shall not constitute as a waiver of that or any other right or remedy. No single exercise by the Seller shall prevent the further exercise of that or any other right or remedy.

(f) Any waiver by the Seller of any breach of, or any default under, any provision of the Contract by the Buyer shall not be deemed a waiver of any subsequent breach or default and shall no way affect the other terms of the Contract.

(g) No term of the Contract shall be enforceable by any person that is not a party to it.

(h) This Condition 23 shall survive termination or cancellation of the Contract.



24. Notices

(a) Any notice to be given by the Buyer under these Conditions or any relevant Contract to the Seller shall be in writing and given by prepaid first class post or hand-delivered to Aflex Hose Limited, Bradley Business Park, Huddersfield, West Yorkshire, HD2 1GZ or to such other address or for the attention of such person as the Seller may notify to the Buyer.

(b) Any notice to be given by the Seller under these Conditions or any relevant Contract to the Buyer shall be in writing and given by prepaid first class post or hand-delivered to any address from which the Seller has received communications from the Buyer in connection with these Conditions or the Contract.

(c) Notices shall be deemed to have been received:

- (i) if sent by prepaid first class post, two (2) Business Days after posting (exclusive of the day of posting); or
- (ii) if delivered by hand, on the day of delivery.

BIOFLEX ULTRA
CORROFLON
CORROLINE+
PHARMALINE N&X
SMOOTHBORE
HYPERLINE FX
VISIFLON

UK

Dyson Wood Way
Bradley Business Park
Huddersfield
West Yorkshire, HD2 1GZ

Tel: +44 (0) 1422 317200

USA

32 Appletree Lane
Pipersville
Bucks County
Pa 18947

Tel: 215 - 766 - 1455
Fax: 215 - 766 - 1688



WWW.AFLEX-HOSE.COM

