

# SPS 200

SPS process pump

## Features and benefits

- Low shear transfer pump, with flow up to 7800 L/h at pressures up to 10 bar
- Superior viscous handling
- Consistent flow with high suction capability up to 0.85 bar
- Flexible configuration of housing, nozzle type, size orientation, drive and baseplate
- Hygienic CIP and SIP capability
- FDA and EC 1935/2004 compliance
- Operating temperatures up to 180 °C
- 20-year guarantee on front cover and pump housing



## Performance curves

These performance curves show the theoretical flow without consideration of slip

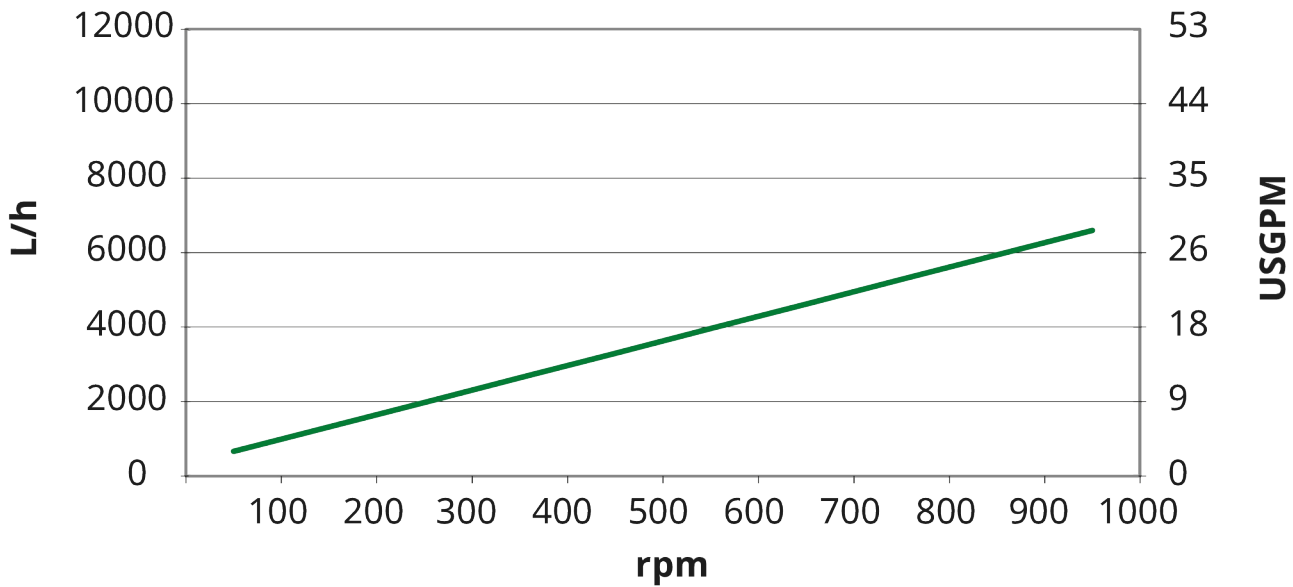

## Technical specifications

	SPS 200
Max. flow rate	7800 L/h
Max. flow rate	34.2 usgpm
Volume per revolution	0.13 L
Volume per revolution	0.034 usg
Max. particle size	20 mm
Max. particle size	0.79 in
Suction pressure	85% of a vacuum
Max. operating speed	1000 rpm
Max. operating pressure	10 bar
Max. operating pressure	145 psi
Operating temperature range	-20 to 180 °C
Operating temperature range	-4 to 356 °F
Standards	ATEX
Certification	EC 1935/2004, FDA
Port orientation	Various options to meet your requirements
Port type	Flange, Milk fitting, RJT, SMS, TC
Shaft diameter	28 mm
Shaft Diameter	1.1 inch
Shaft Height	3.74 inch
Shaft Height	95 mm

## Materials of construction

	SPS 200
Housing	Stainless steel 1.4404, Stainless steel 316L
Bearing frame	Stainless steel 1.4301, Stainless steel 304
Rotor	Stainless steel 1.4404, Stainless steel 316L
Gate and liners	Polyamide
Seals/gaskets	EPDM, FFKM, FKM, NBR, PTFE

## SPS 200 dimensions

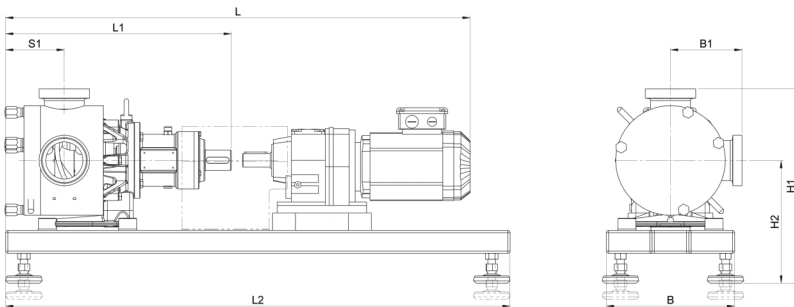

Model	L				L1		L2		S1		B		B1				H1				H2			
	min.		max.										min.		max.		min.		max.		min.		max.	
	mm	inch	mm	inch	mm	inch	mm	inch	mm	inch	mm	inch	mm	inch	mm	inch	mm	inch	mm	inch	mm	inch	mm	inch
SPS 200	740	29.1	960	37.8	345	13.6	800	31.5	95	3.7	210	8.3	106	4.2	137	5.4	314	12.4	344	13.5	208	8.2	238	9.4

Disclaimer: All flow rates shown were obtained pumping water at 20 °C (68 °F) with zero suction and delivery heads. Disclaimer: The information contained in this document is believed to be correct but Watson-Marlow Limited accepts no liability for any errors it contains and reserves the right to alter specifications without notice. Watson-Marlow, MasoSine, Qdos, ReNu, LoadSure, Bioprene, Pumpsil and Marprene are trademarks of Watson-Marlow Limited. STA-PURE PFL® and STA-PURE PCS® are registered trademarks of W.L Gore & Associates Inc. Please state the product code when ordering pumps and tubing.

[wmfts.com/global](http://wmfts.com/global)



31 May 2023