

Reference Manual

DriveSure ADC

DriveSure En

DriveSure Pn



Date of publication: 19 April 2024

Version of publication: 1.8

Language of publication en

DRIVESURE

1 Preface

1.1 Disclaimer

The information contained in this document is believed to be correct, but Watson-Marlow accepts no liability for any errors it contains and reserves the right to alter specifications without notice.

If the product is used in a way that is not intended or described in these instructions, the protection, performance, and/or lifespan may be negatively affected.

1.2 Translation of the original instructions

This instruction handbook has originally been written in English. Other language versions of this instruction handbook are a translation of the original instructions.

Table of contents

1	Preface	2
	1.1 Disclaimer	2
	1.2 Translation of the original instructions	2
2	Introduction to the document	6
	2.1 User groups	6
	2.2 Information types	6
	2.3 Trademarks	7
3	Safety	8
	3.1 Safety symbols	8
	3.2 Safety signals	9
	3.3 Personal Protective Equipment (PPE)	10
4	Product overview	11
	4.1 Introduction	11
	4.2 WM Connect PC Software	11
	4.3 General arrangement	12
	4.4 Intended use	12
	4.5 Pump models	13
	4.6 Accessories	19
	4.7 Product labels	20
	4.8 Product code	21
	4.9 Specification overview	25
5	Storage	47
	5.1 Storage conditions	47
	5.2 Tubing and element shelf life from date of manufacture	47
6	Unpacking	48
	6.1 Components supplied	48
	6.2 Unpacking, inspection, and packaging disposal	48
7	Installation chapter overview	49
	7.1 Installation chapter sequence	49
	7.2 Installation chapter structure	49
8	Installation—Chapter 1: Physical	50
	8.1 Part 1: Chapter installation requirements, specification, and installation	50
	8.2 Part 2: Chapter installation procedures	66

9	Installation—Chapter 2: Electrical power	71
9.1	Part 1: Chapter installation requirements, specification, and information	71
9.2	Part 2: Chapter installation procedures	74
10	Installation—Chapter 3 Overview: Remote Control	75
11	Installation—Sub-Chapter 3A: Remote Control: DriveSure ADC	76
11.1	Part 1: Sub-Chapter installation requirements, specification, and information	76
11.2	Part 2: Sub-Chapter installation procedures	81
12	Installation—Sub-Chapter 3B: Remote Control: DriveSure En	82
12.1	Part 1: Sub-Chapter installation requirements, specification, and information	82
12.2	Part 2: Sub-Chapter installation procedures	93
13	Installation—Sub-Chapter 3C: Remote Control: DriveSurePn	94
13.1	Part 1: Sub-Chapter installation requirements, specification, and information	94
13.2	Part 2: Sub-Chapter installation procedures	105
14	Installation—Chapter 4:Local control	106
14.1	Part 1: Chapter installation requirements, specification, and information	106
14.2	Part 2: Chapter installation procedures	109
15	Installation—Chapter 5: Fluid path	112
15.1	Part 1: Chapter installation requirements, specification, and information	112
15.2	Part 2: Chapter installation procedures	114
16	WM Connect PC software	131
16.1	Part 1: Requirements, specification, and information	131
16.2	Part 2: Procedures	132
17	Operation	135
17.1	Pre-operation checklist	135
17.2	Safety	136
18	Cleaning	137
18.1	Overview	137
18.2	General procedure for guidance	137
19	Maintenance	138
19.1	Spare parts and accessories	138
19.2	Electrical maintenance	139
19.3	Pumphead maintenance	140

20	Errors, breakdown, and troubleshooting	157
20.1	Errors	157
20.2	Error reporting	157
20.3	Breakdown	158
20.4	Troubleshooting	158
20.5	Technical support	161
20.6	Warranty	162
20.7	Returning products	164
21	Chemical compatibility	165
21.1	Overview	165
21.2	Materials of construction	165
21.3	Procedure to check chemical compatibility	170
22	Compliance	171
22.1	Compliance marking	171
22.2	Certification and declaration	172

2 Introduction to the document

2.1 User groups

These instructions are the installation and maintenance instructions, for a Watson-Marlow DriveSure (ADC, En, or Pn) pump, for reference during the products life cycle.

There are two main user groups as defined below:

User group	Definition
Responsible Person	An individual, in or acting on behalf of, the users organisation, responsible for the installation, maintenance, or safe use of the product by operators.
Operator	A person operating the product for its intended use

These instructions may only be referenced by a responsible person. A responsible person must produce final safety information¹ and instructions (installation, operation, and maintenance), for the piece of equipment into which a DriveSure pump will be integrated.

An operator must not use these instructions for reference.

NOTE 1	The form and format of the final safety information and instructions are dependent upon the final design, residual risks, and certification requirements of the piece of equipment into which a DriveSure pump will be integrated.
---------------	------------------------------------------------------------------------------------------------------------------------------------------------------------------------------------------------------------------------------------

2.2 Information types

Specific non-safety information is presented throughout these instructions in the following format:

Information type	Explanation		
Abbreviations	Frequent abbreviations are identified when first used, using brackets, after the full name of the item: Example: Personal Protective Equipment (PPE)		
Note	A note is a piece of additional information to consider. A note is indicated by a superscript . Example: <table border="1" data-bbox="512 1890 1370 1957"><tr><td>NOTE 1</td><td>Body text of note</td></tr></table>	NOTE 1	Body text of note
NOTE 1	Body text of note		





2.3 Trademarks

- DriveSure, PureWeld, Bioprene, Marprene, LoadSure and Pumpsil are registered trademarks of Watson-Marlow Limited.
- PROFINET is a registered trademark of PROFINET International (PI).
- EtherNet/IP is a registered trademark of ODVA, Inc..
- Watson-Marlow, Pumpsil, PureWeld, LoadSure, LaserTraceability, Bioprene and Marprene are registered trademarks of Watson-Marlow Limited. STA-PURE PCS and STA-PURE PFL and Style 400 are trademarks of WL Gore & Associates Inc..
- Tygon is a registered trademark of SAINT-GOBAIN PERFORMANCE PLASTICS CORPORATION

3 Safety

3.1 Safety symbols

The following safety symbols may be used on the product, packaging and in these instructions:

Symbol	Name	Description
	Hot surface	This symbol indicates that the marked item can be hot and should not be touched without taking precautions
	PPE required	This symbol indicates Personal Protective Equipment (PPE) must be worn prior to a task
 Either symbol	Rotating parts	This symbol indicates rotating parts which should not be touched without following a safety instruction
	Potential hazard	This symbol identifies that an appropriate safety instruction should be followed or a potential hazard exists

3.1.1 Replacing safety labels

If the safety labels on the product become accidentally damaged, contact your local Watson-Marlow representative for information on obtaining replacements.

3.2 Safety signals

Signals indicate a possible hazard. Signal are used in these instructions when immediately relevant to the information, task or procedure.

3.2.1 Signals: With risk of personal injury

Signals indicating risk of a personal injury are presented when relevant to a task in this format:

CAUTION	
The CAUTION signal word indicates a hazard. Risk of minor or moderate injury exists if the hazard is not avoided. Equipment or property damage may also occur.	
 <p>A safety symbol indicates a hazard with personal injury risk.</p>	<p>Hazard information—Information to explain:</p> <ul style="list-style-type: none">• Hazard type or nature of hazard• What could happen• How to avoid hazard

3.2.2 Signals: With risk of equipment or property damage only

Signals indicating risk of equipment or property damage only are presented when relevant to a task in this format:

NOTICE	
The NOTICE signal word indicates a hazard. Risk of equipment or property damage only.	
<p>Hazard information—Information to explain:</p> <ul style="list-style-type: none">• Hazard type or nature of hazard• What could happen• How to avoid hazard	

3.3 Personal Protective Equipment (PPE)

The following minimum PPE will be required for any task or procedure in these instructions.

1. Safety glasses
2. Safety boots
3. Gloves chemically compatible with the chemicals being pumped

A risk assessment by a responsible person must be undertaken to identify if:

- Suitability of PPE for any task or procedure in these instructions.
- If additional PPE is required for any task or procedure in these instructions.

4 Product overview

This section provides a product and specification overview.

4.1 Introduction

Watson-Marlow DriveSure integrates motor, mounting, our latest generation control technology, and WM Connect PC software to deliver powerful performance. Designed for integration into equipment, such as a cabinet or casing. All DriveSure models are positive displacement peristaltic pumps, fully tested and certified, ensuring reliability in a range of applications.

As a complete panel-mount solution, DriveSure helps OEMs to reduce time-to-market and achieve competitive gain by simplifying each stage of the development process.

DriveSure features our next generation digital, closed-loop control technology which delivers enhanced speed control for accurate flow rates, coupled with cool and quiet performance.

High speed accuracy and stability across the range is achieved by tuning specifically for peristaltic pump applications.

Cool running is achieved by continuously adjusting motor phase current in response to the torque requirement, avoiding excess current and therefore heat. If the load increases unexpectedly due to changes in the application, DriveSure can manage higher than expected loads in a controlled and safe manner through its closed-loop control.

4.2 WM Connect PC Software

The WM Connect software is available for use with DriveSure. It may be used for:

- Configuring pump control and performance settings
- Manual override for testing performance and simulating faults
- Viewing pump status information
- Load/save pump configurations
- Performing pump firmware updates
- Viewing pump log

See section 16 for full information.

4.3 General arrangement

A general arrangement illustration is provided below:

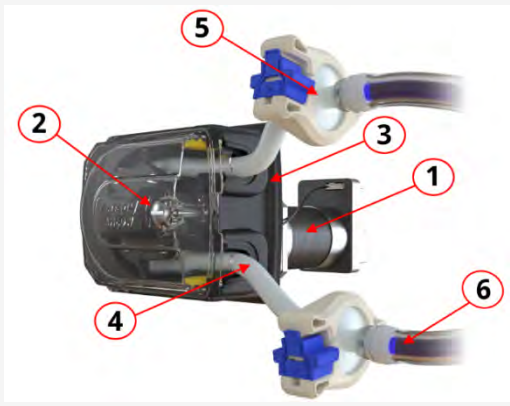
Item Number	Name	Picture showing item
1	Pump drive	
2	Peristaltic pumphead	
3	Pumphead mounting plate	
4	Peristaltic (tubing or element)	
5	Connection to process fluid path	
6	Process fluid path	

4.4 Intended use

All DriveSure models are designed as components requiring integration into other equipment or system, prior to use; To provide controlled fluid¹ movement, in ordinary safe locations, except fluids or applications listed below:

4.4.1 Prohibited use:

- Environments that require explosion proof certification.
- With flammable fluids.
- Applications which are directly life sustaining.
- Applications within a Nuclear Island.

NOTE 1 A procedure for checking chemical compatibility with fluids is provided: ([See page 165](#))

4.5 Pump models

A DriveSure pump is a combination of

- A DriveSure drive model
- A Watson-Marlow pumphead model

The model variation, general arrangement, and features of each of these components are explained in the following sub-sections.

4.5.1 Drive: Models

There are 3 models of drive

- DriveSureADC model: Control by 4–20 mA, 0–10 V, 2–2000 Hz
- DriveSureEn model: Network control by EtherNet/IP
- DriveSurePn model: Network control by PROFINET

4.5.2 Drive: General arrangement

The general arrangement of a DriveSure drive is illustrated below

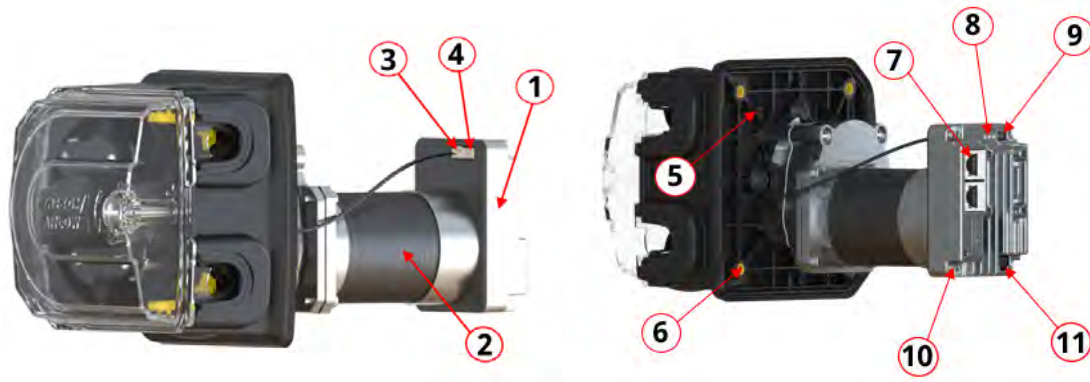

520R2DriveSureEn2.4 mm WT model shown, the exact appearance and arrangement will vary with model.





Item Number	Name
1	Integrated Controller
2	Motor
3	Connection for integrated cover-open sensor cable
4	Connection for prime switch cable
5	Mounting plate alignment features
6	Threaded brass inserts for pump mounting bolts
7	Remote control connection
8	Status LEDs
9	USB-C connection for WM Connect PC software
10	Functional earth terminal ¹
11	Power supply connection

NOTE 1

A M4 x 0.7 threaded hole (4.0 mm thread depth) is provided as an optional functional earth terminal.





4.5.3 Pumphead: Models

A DriveSure pump may be ordered with any of the following Watson-Marlow pumpheads.

Pumphead Series	Pumphead models	Image
100 Series	<ul style="list-style-type: none"> • 114DV • 114DVP 	
300 Series	<ul style="list-style-type: none"> • 313D • 313D2 • 314D • 314D2 	
400 Series	<ul style="list-style-type: none"> • RXMD 	
500 Series	<ul style="list-style-type: none"> • 520R • 520R2 • 520REL • 520REM 	

4.5.4 Pumphead: General arrangement

The general arrangement of a pumphead is provided in the image below

100 Series		300 Series	
			
400 Series		500 Series	
			
Item Number	Name		
1	Pumphead cover ¹		
2	Rotor ²		
3	Tubing clamps ³		
4	Peristaltic tubing (or element)		
5	Pumphead mounting plate		

NOTE 1 Tool unlockable (500 Series only)

NOTE 2 Specific to tubing type and pressure (500 Series only)



NOTE 3 Continuous tube only

4.5.5 Pumphead: Tubing

A Watson-Marlow pumphead, provides fluid flow, by the principle of positive displacement, using a Watson-Marlow peristaltic tube installed inside the pumphead.

4.5.5.1 Tubing: types

Watson-Marlow pumpheads are designed for use with two main types of peristaltic tubing:

Tubing type name	Fluid connection style	Picture
Continuous tube type	A continuous tube, available in various length, to be cut to size for use in an applicaton.	
LoadSure tubing element type	A set length, with built in fluid connectors, for fast and accurate tube changes without the need to set tubing clamps or tension tube.	



4.5.5.2 Tubing: materials

Tubing is available in the following main materials.

Tubing name	Material
Marprene	Thermoplastic elastomer
Bioprene	Thermoplastic elastomer
Pumpsil	Platinum cured silicone
PureWeld XL	SEBS
STA-PURE PCS	ePTFE and platinum-cured silicone composite
STA-PURE PFL	ePTFE and platinum-cured perfluoroelastomer
Tygon E-LFL	PVC
Tygon E-3603	PVC

4.5.5.3 LoadSure element: sub-types

LoadSure elements are divided further into two sub-types

Element Sub-type name	Fluid connection style	Picture
Sanitary	For use with a fluid connector seal and outer connection clamp	 A photograph of a white plastic sanitary fluid connector. It features a blue O-ring seal at the top where it meets a tube, and a clear plastic clamp mechanism on the side to secure the connection.
Industrial	For use with a fluid connector seal and click fit female fluid connector.	 A photograph of a white plastic industrial fluid connector. It has a clear plastic clamp on the side and a female connector port at the bottom, designed for a click-fit connection with a male tube.

4.5.5.4 Tubing: size

Tubing and element sizes are referenced by the bore (internal diameter) dimension followed by wall thickness.

Example: 6.4 mm bore x 1.6 mm wall thickness

Specific size tubing may only be installed in specific pumpheads:

Tubing	Suitable pumphead
Continuous tubing with a 1.6 mm wall thickness	114DV, 114DVP, 313D, 314D, RXMD, 520R
Continuous tubing with a 2.4 mm wall thickness	313D2, 314D2, 520R2
Watson-Marlow LoadSure elements	520REL, 520REM

Not all tubing is available in all materials, all sizes, all lengths, or all types (continuous, element). Contact your local Watson-Marlow representative for specific availability.

4.6 Accessories

A DriveSure pump is available with the following Watson-Marlow accessories

Type	Product name	Product code
Control cable ¹	Ethernet Cable, RJ45 to RJ45, CAT 5e SHIELDED, 3m (9.84 Ft)	059.9123.000
	PROFINET Cable, RJ45 to RJ45, CAT 5e SHIELDED, 3m (9.84 Ft)	059.9128.000
Cable pack ²	DriveSure cable pack - 24V power supply/USB-C - trials only	009.24CP.DVS
	DriveSure cable pack - 48V power supply/USB-C - trials only	009.48CP.DVS

NOTE 1 DriveSure En, or Pn pumps are not supplied with a control cable. DriveSure ADC, includes the control cable with corresponding 8-pin connector.

NOTE 2 The cable pack is for trial use only. It includes an AC to DC power adapter, and USB-C cable. The power adapter in the cable pack does not include the mains power lead. These can be ordered separately with the correct country plug. Contact your local Watson-Marlow representative for more information.

Do not fit any devices or accessories other than those approved by Watson-Marlow or as specified in these instructions.

4.7 Product labels

3 labels are provided on the product (DriveSureEn model shown):

Number	Name	Picture
1	DC Power supply requirement	
2	Date of manufacture	
3	Functional earth terminal	
4	Ambient operating temperature	
5	Network MAC Address	
6	Network port numbers	
7	Product serial number	
8	Product part number	
9	Safety symbols	
10	QR code for instructions	
11	Website address for instructions	
12	Symbol: refer to these instructions	
13	Compliance symbols	

4.8 Product code

A DriveSure pump product code is a unique string of numbers as illustrated by the graphic and tables in the subsections below:

4.8.1 100 series



A	B	C	D	E	F
Product	Control	Cable length ¹	Pumphead colour	Pumphead	Pressure
0 = Complete pump	4 = ADC	1 = 1 m (3.28 ft) cable	0 = No pumphead	0 = No pumphead	0 = No pumphead
6 = Drive only	8 = En (EtherNet/IP)	3 = 3 m (9.84 ft) cable	1 = Standard colour	A = 114DV	S = Standard pressure
	9 = Pn (PROFINET)		2 = Black		P = Plus pressure
			3 = White		

NOTE 1

Control and power cables are both supplied in the length specified in the part number. Example: If position C = 3 then both cables are 3 m long

4.8.2 300 series



A	B	C	D
Product	Control	Cable length¹	Pumphead colour
0 = Complete pump	4 = ADC	1 = 1 m (3.28 ft) cable	0 = No pumphead
6 = Drive only	8 = En (EtherNet/IP)	3 = 3 m (9.84 ft) cable	1 = Standard colour
	9 = Pn (PROFINET)		2 = Black
			3 = White
E	F	G	H
Motor Type	Pumphead	Tube clamp	Tube wall thickness
A = Standard NEMA 24 stepper motor	0 = No pumphead	0 = No pumphead	0 = No pumphead
C = High torque NEMA 24 stepper motor	C = 313D/313D2	V = Variable	1 = 1.6 mm
	D = 314D/314D2	C = Fixed 0.5 to 1.6 mm bore	2 = 2.4 mm
		F = Fixed 3.2 mm bore	
		K = Fixed 4.8 to mm bore	
	N = Fixed 6.4 to 8.0 mm bore		

NOTE 1

Control and power cables are both supplied in the length specified in the part number. Example: If position C = 3 then both cables are 3 m long

4.8.3 400 Series



A	B	C	D	E
Control	Cable length¹	Direction	Max Pressure	Tube bore size
4 = ADC	1 = 1 m (3.28 ft) cable	1 = Clockwise (CW)	4 = 4 bar	3 = 1.6 mm
8 = En (EtherNet/IP)	3 = 3 m (9.84 ft) cable	2 = Counter clockwise (CCW)	6 = 6 bar	4 = 3.2 mm
9 = Pn (PROFINET)				

NOTE 1

Control and power cables are both supplied in the length specified in the part number. Example: If position B = 3 then both cables are 3 m long

4.8.4 500 series

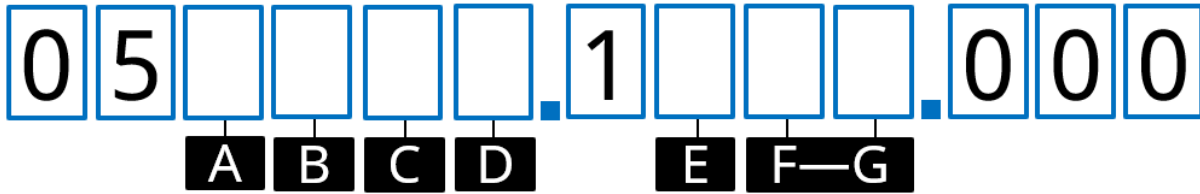

A	B	C	D	E	F-G
Product	Control	Cable length ¹	Pumphead Colour	Pumphead	Pumphead Model
0 = Complete pump	4 = ADC	1 = 1 m (3.28 ft) cable	0 = No pumphead	0 = No pumphead	00 = No pumphead
6 = Drive only	8 = En (EtherNet/IP)	3 = 3 m (9.84 ft) cable	1 = Standard colour	R = 500 Series	10 = 520R
	9 = Pn (PROFINET)				2L = 520R2
					EL = 520REL
					EM = 520REM

NOTE 1

Control and power cables are both supplied in the length specified in the part number. Example: If position C = 3 then both cables are 3 m long

4.9 Specification overview

This section provides an overview of specification. Detailed installation specification is provided when relevant to the installation task.

4.9.1 Performance overview

The flowrate of the pump depends on

- Speed of the pump¹
- Pumphead
 - Tubing material
 - Direction of rotor rotation
- Application pressure at pumphead inlet and discharge fluid path connections²
- Fluid viscosity

NOTE 1 The maximum speed of the pump is dependent on power supply voltage, discharge pressure and tubing material

NOTE 2 Pressures values in this section are root mean squared gauge pressures, measured inline, immediately before the inlet and after the discharge tubing clamps.

4.9.2 100 Series performance

4.9.2.1 100 Series 48 V DC performance summary table

Flow rates in the table below are based on the following conditions:

- Pumping water at 20 °C in a 0 bar inlet and discharge pressure application
- 48 V DC power supply

Flow rate ¹ (mL/min) by tube bore based on 0.1 rpm (Min) to 410 rpm (Max)															
		0.5 mm		0.8 mm		1.6 mm		2.4 mm		3.2 mm		4.0 mm		4.8 mm	
		Min	Max	Min	Max	Min	Max	Min	Max	Min	Max	Min	Max	Min	Max
114DV		0.00 2	9.3	0.00 4	17.4	0.01 4	57.4	0.02 9	118	0.04 8	195	0.06 8	276. 8	0.08 5	349
114DVP		0.00 2	9.3	0.00 4	17.4	0.01 4	57.4	0.02 9	118	0.04 8	195	0.06 8	276. 8	0.08 5	349

NOTE 1

Reduce the flowrates in the table by 10% for Pumpsil tubing.

Refer to performance curve, for graphical representation of flow rate versus application pressure under certain conditions.

4.9.2.2 100 Series 48 V DC performance curve

The flowrate versus application pressure of a 114DV or 114DVP pumphead under the following conditions is shown in the performance curves:

- 48 V DC power supply
- Marprene tube
- Pumping water at 20 °C
- Counter-clockwise direction
- 100 rpm

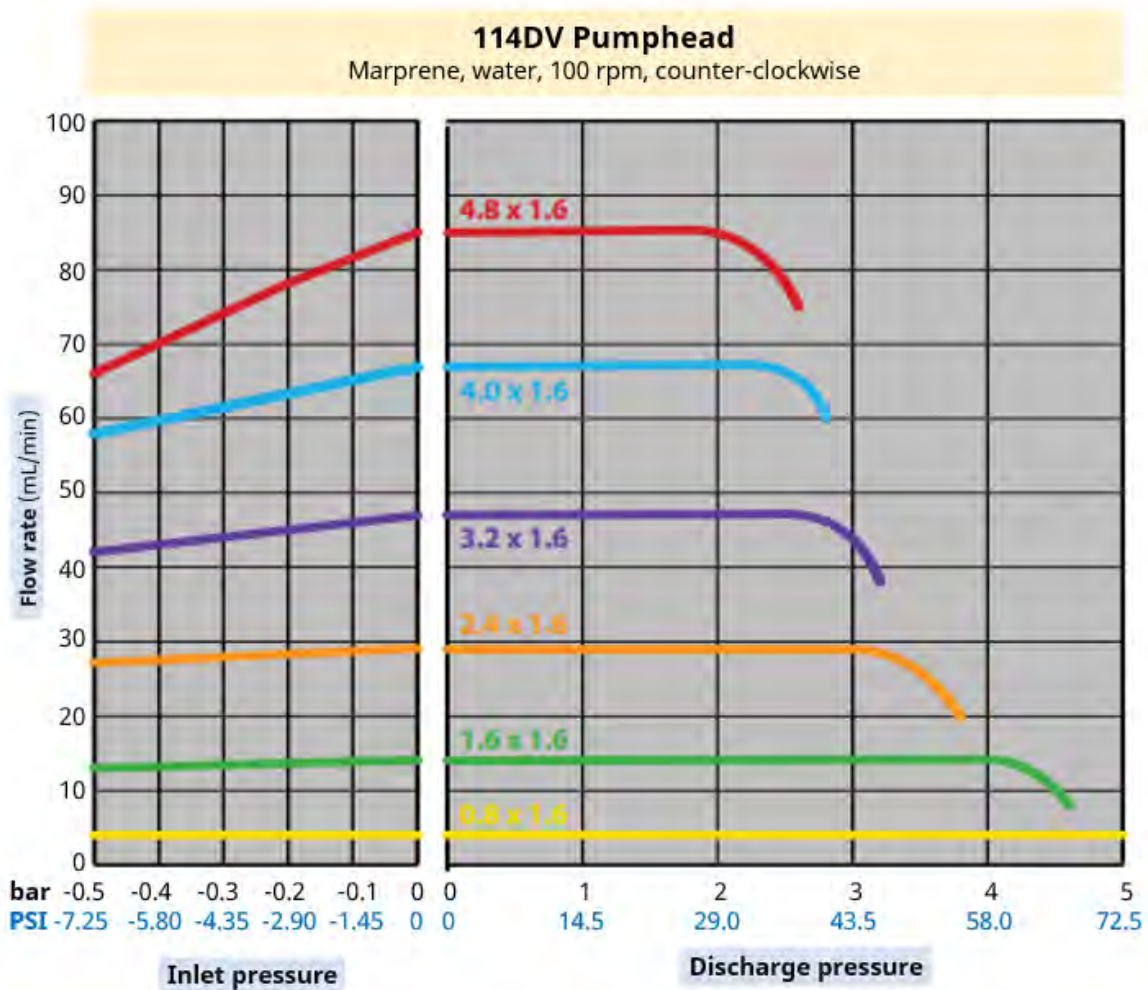

114DVP Pumphead

Marprene, water, 100 rpm, counter-clockwise

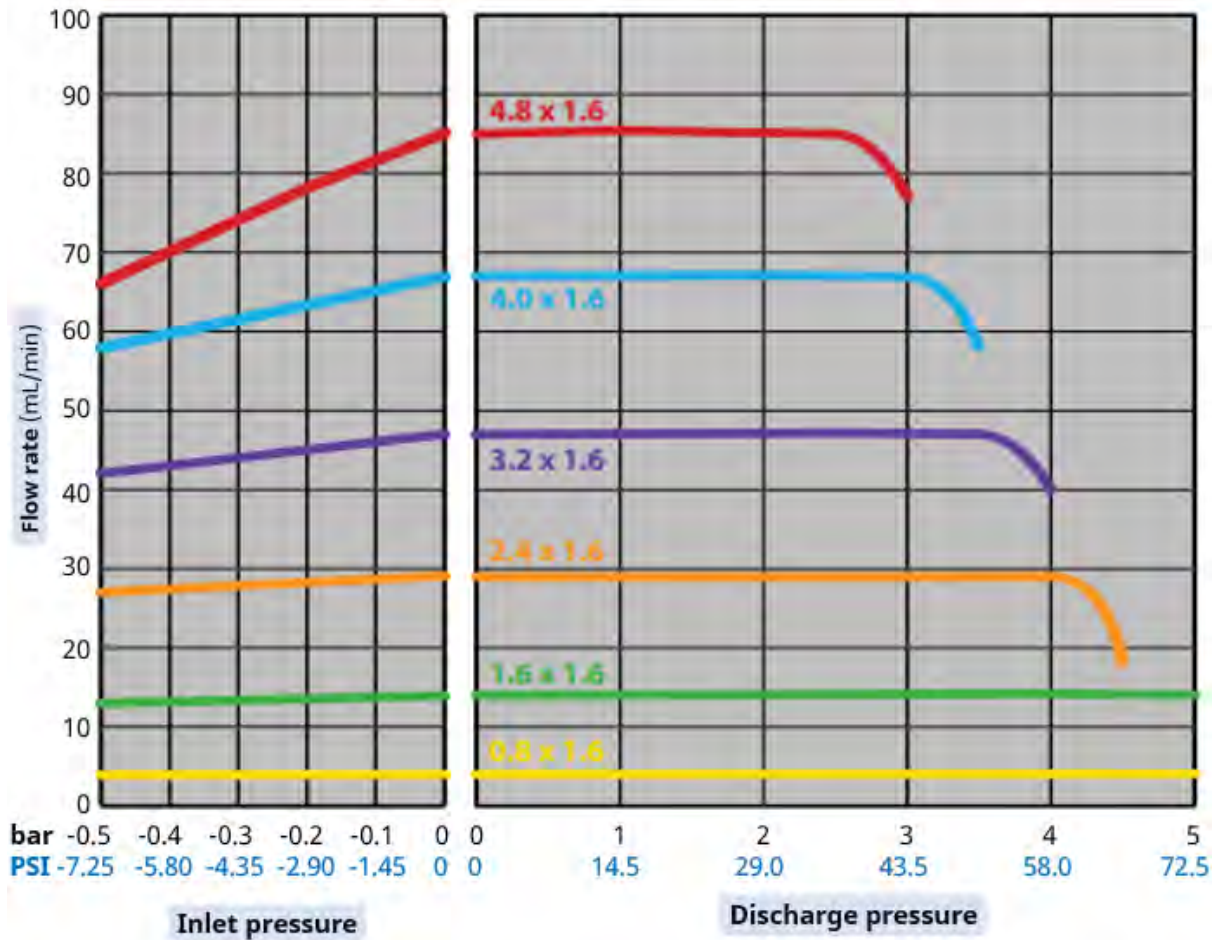

The following conditions may influence achievable flow rates:

- Other power supply voltages
- Other fluid viscosities
- Other tubing materials
- Different speeds than 100 rpm
- A clockwise direction

Achievable flow rates should be determined in a user's system through application testing.

4.9.3 300 Series performance

4.9.3.1 300 Series 48 V DC performance summary table

Flow rates in the table below are based on the following conditions:

- Pumping water at 20 °C in a 0 bar inlet and discharge pressure application
- 48 V DC power supply

Flow Rate (mL/min) by tube bore based on 0.1 rpm (Min) to 410 rpm (Max)														
	0.5 mm		0.8 mm		1.6 mm		3.2 mm		4.8 mm		6.4 mm		8.0 mm	
	Min	Max	Min	Max	Min	Max	Min	Max	Min	Max	Min	Max	Min	Max
313D	0.00 3	12.1	0.00 7	29.1	0.02 7	112. 5	0.10 0	410	0.22 1	904	0.36 8	150 7	0.50 0	205 0
314D	0.00 3	12.1	0.00 6	24.1	0.02 5	102. 5	0.08 6	352	0.19 1	784	0.30 0	123 0	0.40 0	164 0
313D2	0.00 3	12.1	0.00 7	29.1	0.02 7	112. 5	0.10 0	410	0.22 1	904	0.36 8	150 7		
314D2	0.00 3	12.1	0.00 6	24.1	0.02 5	102. 5	0.08 6	352	0.19 1	784	0.30 0	123 0		

Refer to performance curve, for graphical representation of flow rate versus application pressure under certain conditions.

4.9.3.2 300 Series 48 V DC performance curve

The flowrate versus application pressure of a 313D or 314D pumphead under the following conditions is shown in the performance curves:

- 48 V DC power supply
- Marprene tube
- Pumping water at 20 °C
- Counter-clockwise direction
- 100 rpm

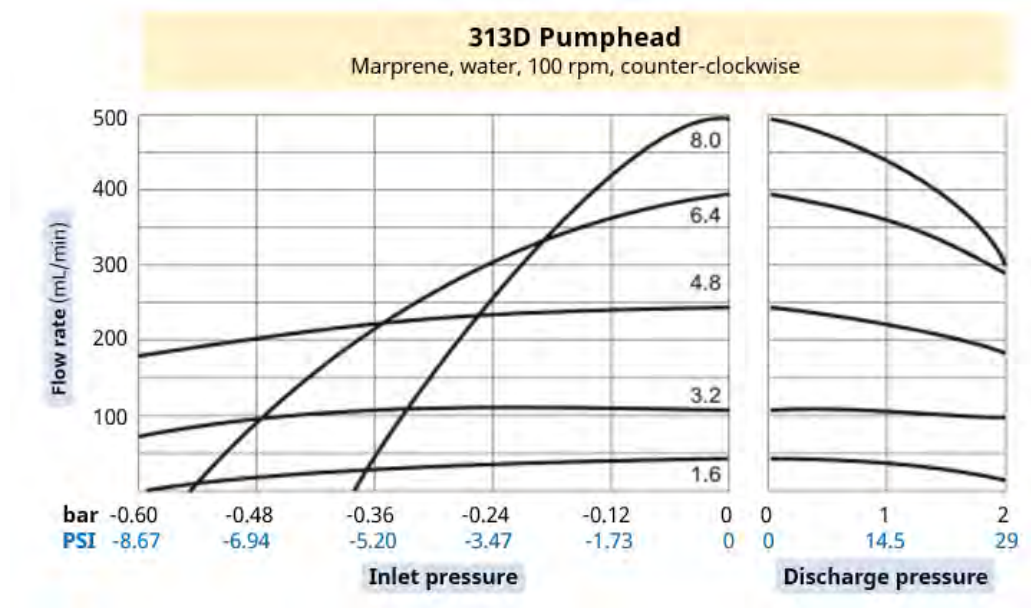

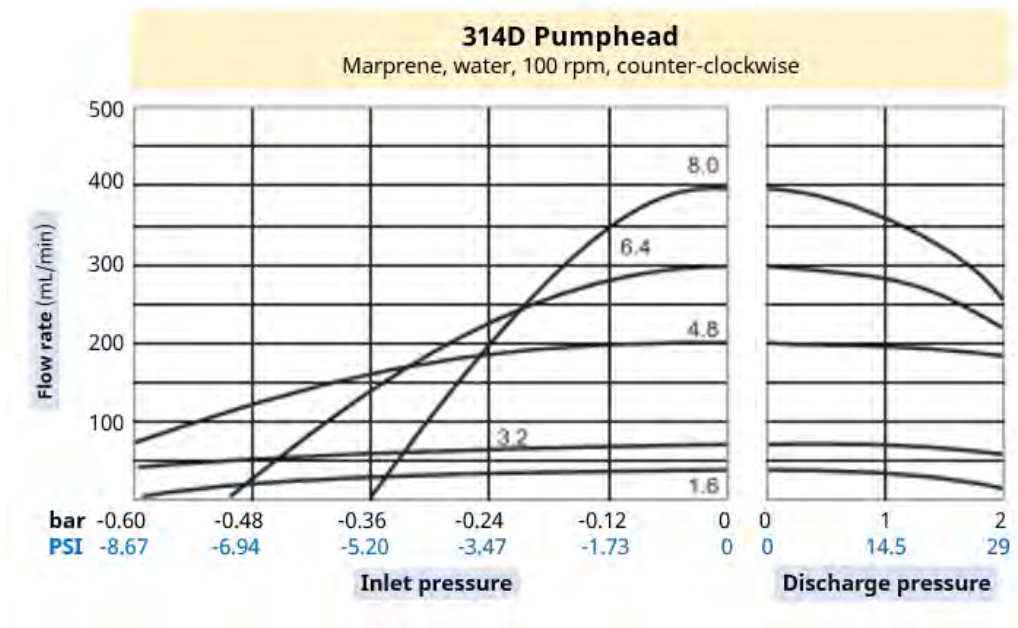

The following conditions may influence achievable flow rates:

- Other power supply voltages
- A 313D2 or 314D2 pumphead
- Other fluid viscosities
- Other tubing materials
- Different speeds than 100 rpm
- A clockwise direction

Achievable flow rates should be determined in a user's system through application testing.

4.9.4 400 Series performance

4.9.4.1 400 Series 48 V DC performance summary table

Flow rates in the table below are based on the following conditions:

- Pumping water at 20 °C in a 0 bar inlet and discharge pressure application
- 48 V DC power supply
- Tygon E-3603 tubing

Flow Rate (mL/min) by tube bore based on 0.1 rpm (Min) to 550 rpm (Max)					
		1.6 mm		3.2 mm	
	Min	Max	Min	Max	
RXMD	0.025	137	0.091	500	

Refer to performance curve, for graphical representation of flow rate versus application pressure under certain conditions.

4.9.4.2 400 Series 48 V DC performance curve

The flowrate versus application pressure of a RXMD pumphead under the following conditions is shown in the performance curves:

- 48 V DC power supply
- Tygon E-3603 tubing
- Pumping water at 20 °C
- 200 rpm

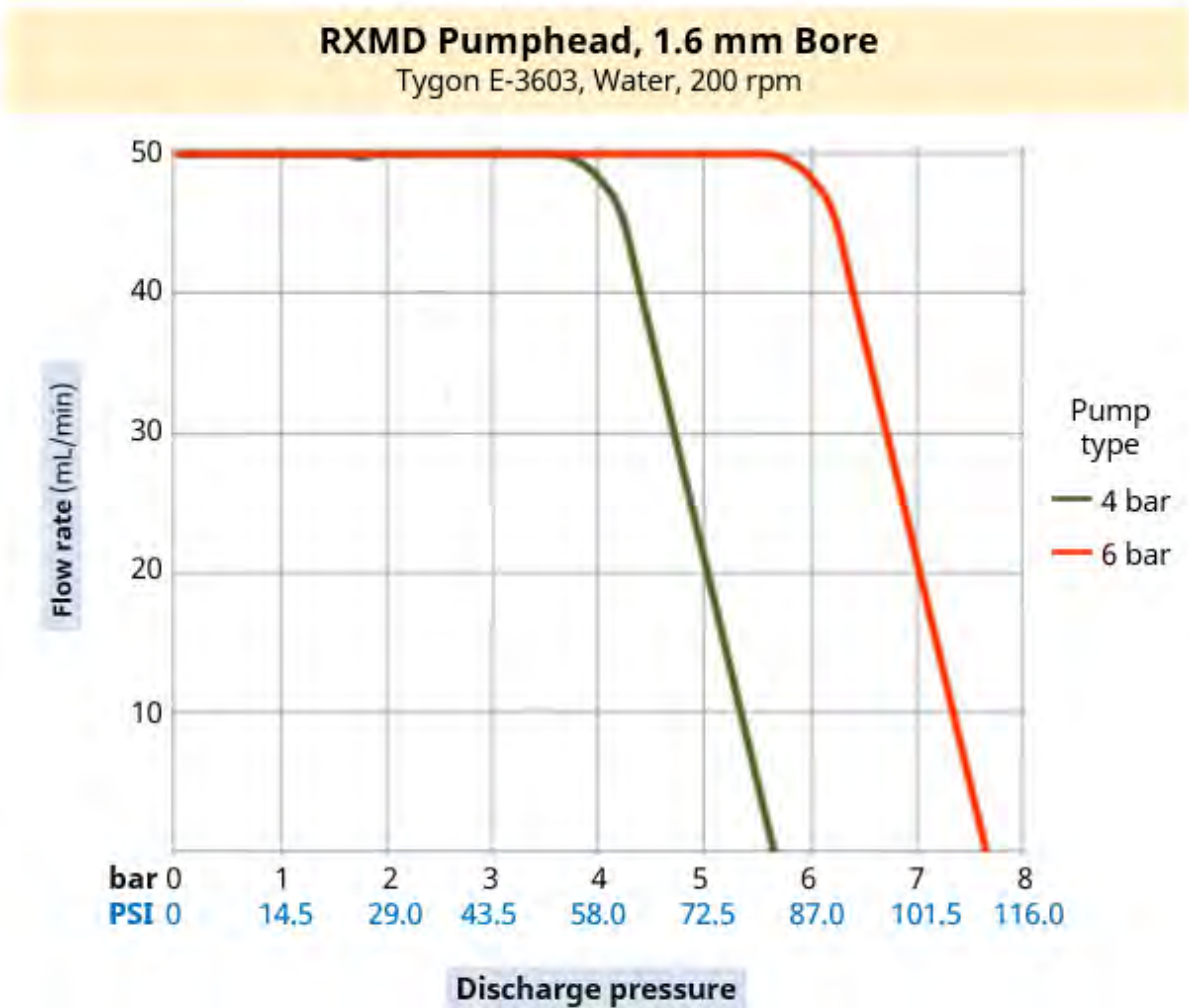

RXMD Pumphead, 3.2 mm Bore

Tygon E-3603, Water, 200 rpm

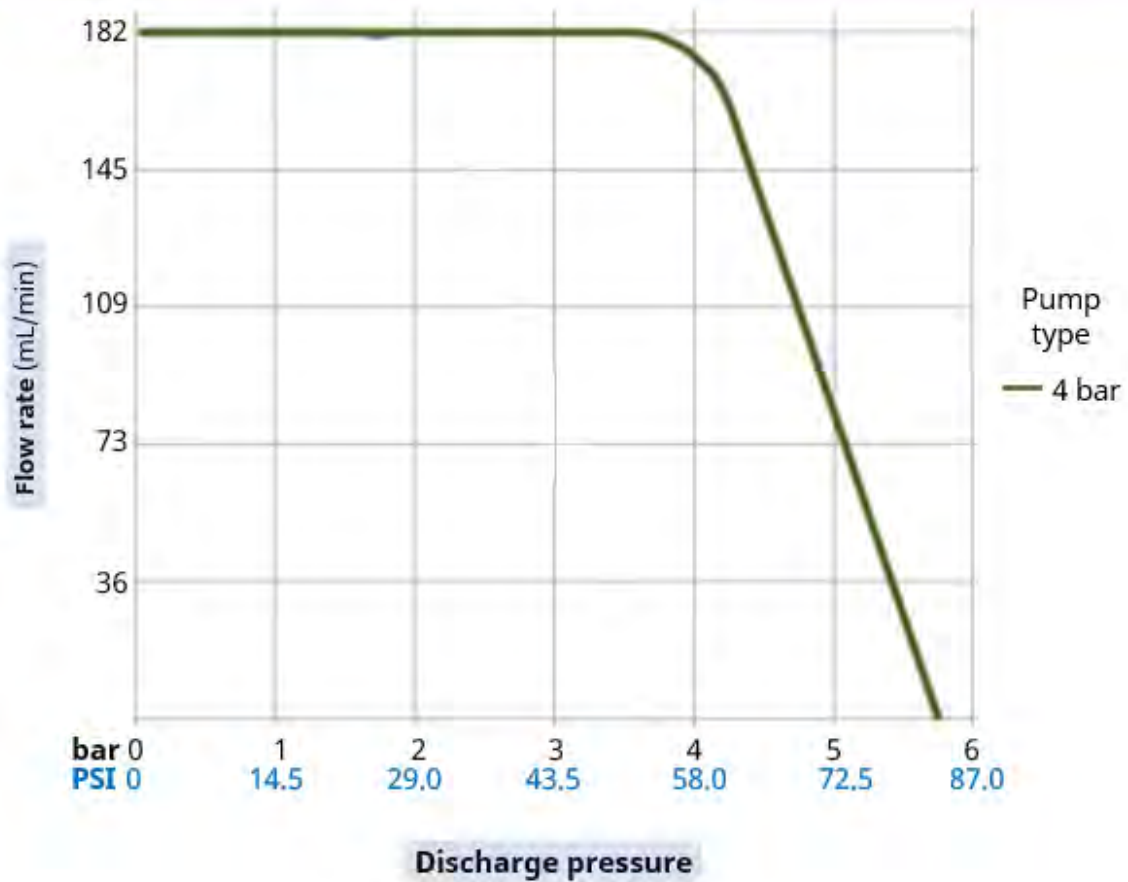

The following conditions may influence achievable flow rates:

- Other power supply voltages
- Inlet pressure
- Other fluid viscosities
- Other tubing materials
- Different speeds than 200 rpm

Achievable flow rates should be determined in a user's system through application testing.

4.9.5 500 Series performance

4.9.5.1 500 Series 48 V DC performance summary table

Flow rates in the table below are based on the following conditions:

- Pumping water at 20 °C in a 0 bar inlet and discharge pressure application
- 48 V DC power supply

520R Pumphead for continuous tubing (1.6 mm wall thickness) up to 2 bar (29 PSI)																		
Flow Rate (mL/min) by tube bore from 0.1 rpm (Min) to 220 rpm (Max)																		
	0.5 mm		0.8 mm		1.6 mm		3.2 mm		4.8 mm		6.4 mm		8.0 mm					
Tube material	Min	Max	Min	Max	Min	Max	Min	Max	Min	Max	Min	Max	Min	Max				
Pumpsil	0.004	9.5	0.011	24														
STA-PURE PCS					0.04	97	0.18	390	0.40	870	0.70	1500	1.10	2400				
STA-PURE PFL																		
Marprene	0.004	9.0	0.011	24														
Bioprene	0.004	9.0	0.011	24	0.04	92	0.17	370	0.38	830	0.67	1500	1.10	2300				
PureWeld XL	0.004	9.0																
520R2 Pumphead for continuous tubing (2.4 mm wall thickness) up to 2 Bar (29 PSI)																		
Flow Rate (mL/min) by tube bore from 0.1 rpm (Min) to 220 rpm (Max)																		
	0.5 mm		0.8 mm		1.6 mm		3.2 mm		4.8 mm		6.4 mm		8.0 mm		9.6 mm			
Tube material	Min	Max	Min	Max	Min	Max	Min	Max	Min	Max	Min	Max	Min	Max	Min	Max		
Pumpsil	0.004	9.5	0.011	24														
STA-PURE PCS					0.04	97	0.18	390	0.40	870	0.70	1500	1.10	2400	1.60	3500		
STA-PURE PFL																		
Marprene																		
Bioprene					0.04	92	0.17	370	0.38	830	0.67	1500	1.10	2300	1.50	3300		
PureWeld XL																		
520REL Pumphead for LoadSure TL elements up to 2 Bar (29 PSI)																		
Flow Rate (mL/min) by tube bore from 0.1 rpm (Min) to 220 rpm (Max)																		
							3.2 mm								6.4 mm		9.6 mm	
LoadSure element							Min	Max							Min	Max	Min	Max
Pumpsil																		
STA-PURE PCS							0.18	390							0.70	1500	1.60	3500
STA-PURE PFL																		
Marprene TL																		
Bioprene TL							0.17	370							0.67	1500	1.50	3300

520REM Pumphead for LoadSure™ elements up to 4 Bar (58 PSI)					
Flow Rate (mL/min) by tube bore from 0.1 rpm (Min) to 220 rpm (Max)					
LoadSure element	3.2 mm		6.4 mm		
	Min	Max	Min	Max	
STA-PURE PCS	0.18	390	0.70	1500	
STA-PURE PFL					
Marprene™	0.17	370	0.67	1500	
Bioprene™					

Refer to performance curve, for graphical representation of flow rate versus application pressure under certain conditions.

4.9.5.2 500 Series 48 V DC performance curve

The flowrate versus application pressure of a 500 Series pumphead under the following conditions is shown in the performance curves:

- 48 V DC power supply
- Marprene tube
- Pumping water at 20 °C
- Counter-clockwise direction
- 220 rpm

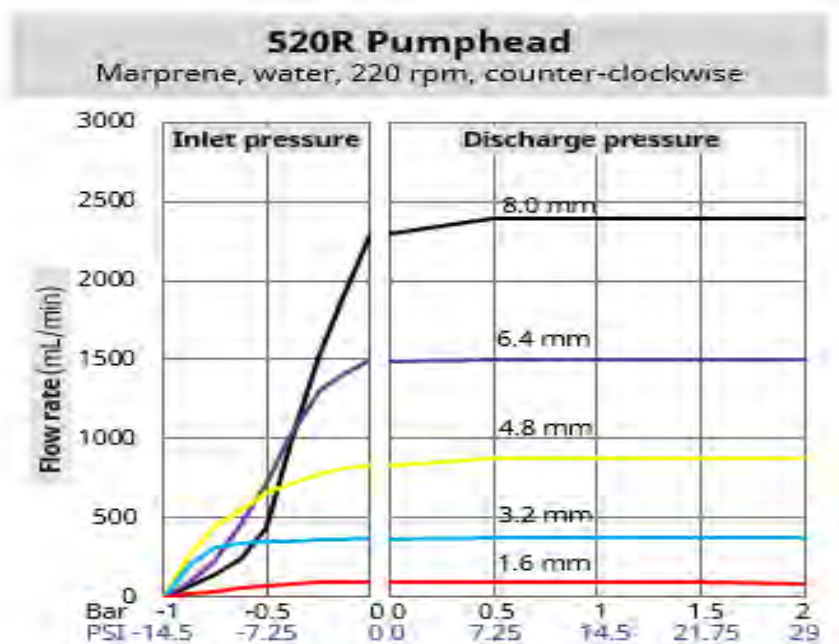

520R2 Pumphead

Marprene, water, 220 rpm, counter-clockwise

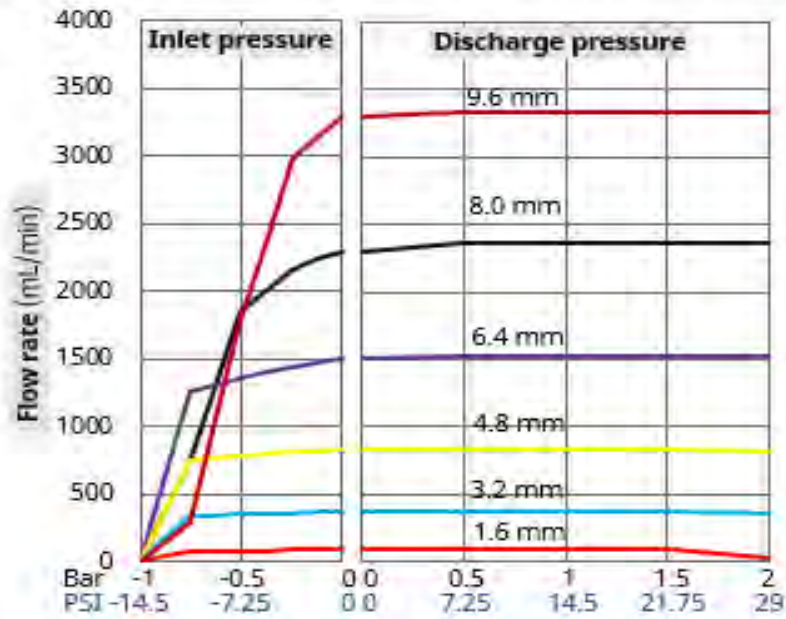

520REL Pumphead

Marprene, water, 220 rpm, counter-clockwise

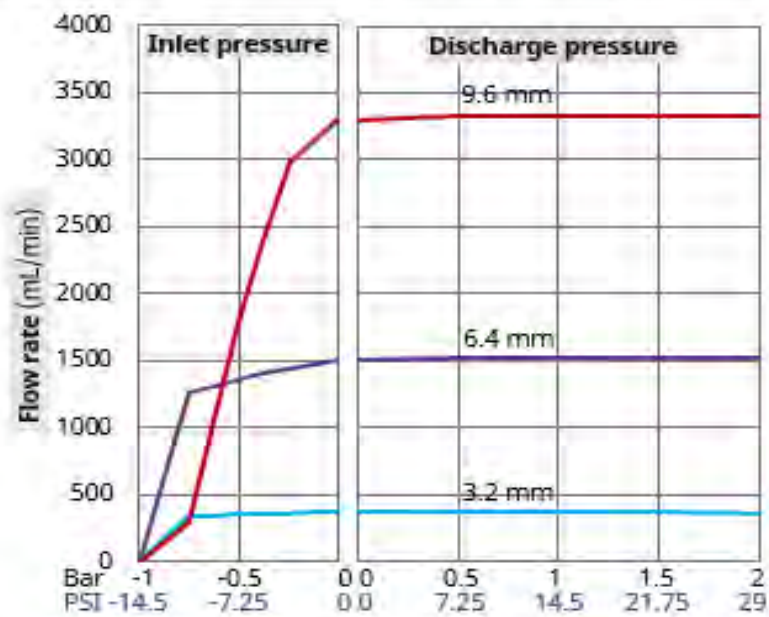

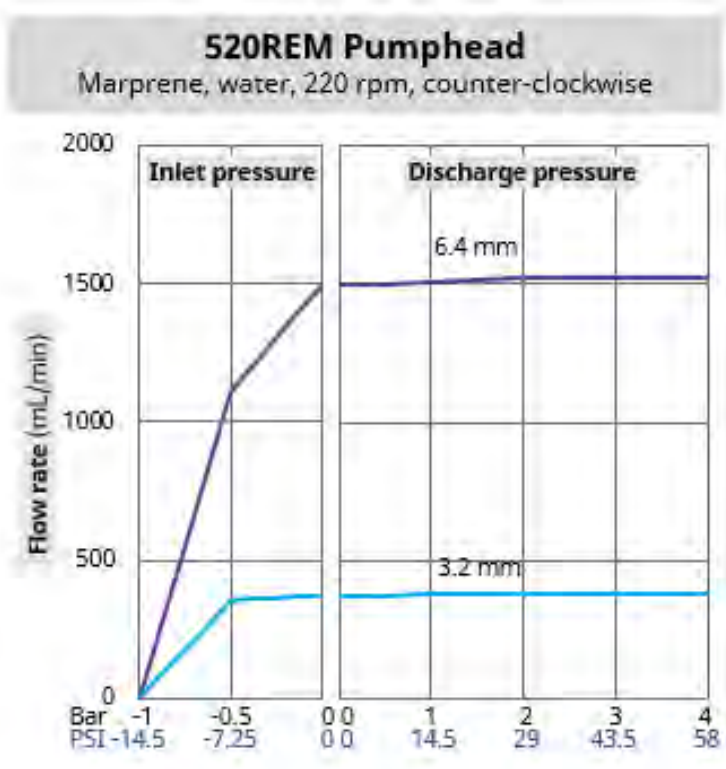

The following conditions may influence achievable flow rates:

- Other power supply voltages
- Other fluid viscosities
- Other tubing materials
- Different speeds than 220 rpm
- A clockwise direction

Achievable flow rates should be determined in a user's system through application testing.

4.9.6 Physical specification

4.9.6.1 Environmental and operating conditions

Name	Specification
Ambient temperature range	5 °C to 40 °C (41 °F to 104 °F)
Humidity (non-condensing)	80 % up to 31 °C (88 °F), decreasing linearly to 50 % at 40 °C (104 °F)
Maximum altitude	2,000 m, (6,560 ft)
Pollution degree of the intended environment	2
Location	Indoor

4.9.6.2 Ingress protection

100, 300 and 500 series DriveSure models are capable of passing an IP66 test when mounted in a suitable enclosure. In isolation, these models do not have an Ingress Protection (IP) rating.

400 RXMD DriveSure 400 series models require additional measures to achieve an IP rating.

For more information contact your Watson-Marlow representative.

4.9.6.3 Noise

	100 Series	300 Series	400 Series	500 Series
Noise	<60 dB(A) at 1m	<60 dB(A) at 1m	<70 dB(A) at 1m	<65 dB(A) at 1m

4.9.6.4 Panel thickness

Mounting plate and fixing bolts have been designed to the following panel thickness:

	Unit	
	mm	In
Minimum panel thickness	1.5	0.059
Maximum panel thickness	3.0	0.118

This is to ensure sealing between the mounting plate and the panel. Panels outside of this should be assessed for overall mounting and sealing, such as mounting bolt length and mounting plate size/support.

4.9.6.5 Dimensions: 100 Series

The dimensions of the product are provided in the illustration and table below:

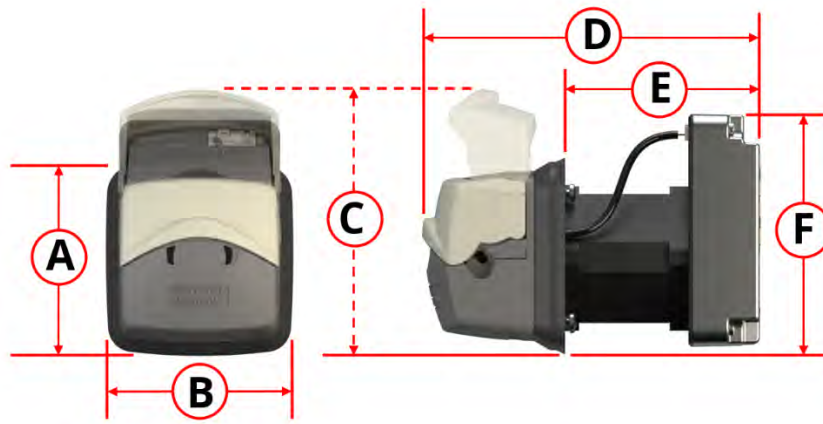

A		B		C		D		E		F	
mm	In	mm	in	mm	in	mm	in	mm	in	mm	in
73	2.87	74	2.91	98	3.85	128	5.04	73	2.87	89	3.50

4.9.6.7 Dimensions: 400 Series

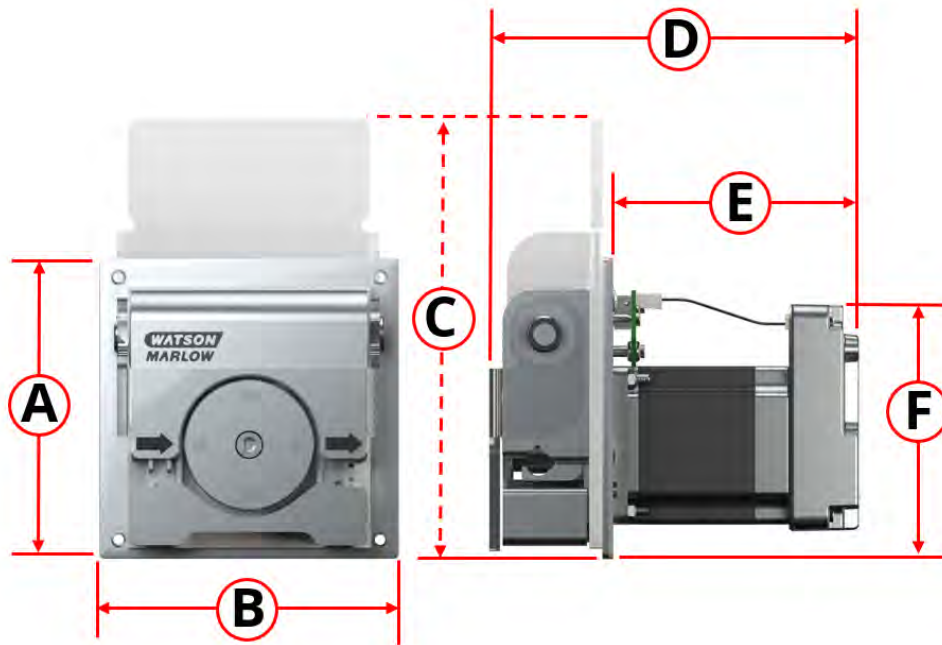

The dimensions of the product are provided in the illustration and table below:

A		B		C		D		E		F	
mm	In	mm	in	mm	in	mm	in	mm	in	mm	in
114	4.49	114	4.49	167	6.57	142	5.39	96	3.78	97	3.82

4.9.6.8 Dimensions: 500 Series

The dimensions of the product are provided in the illustration and table below:

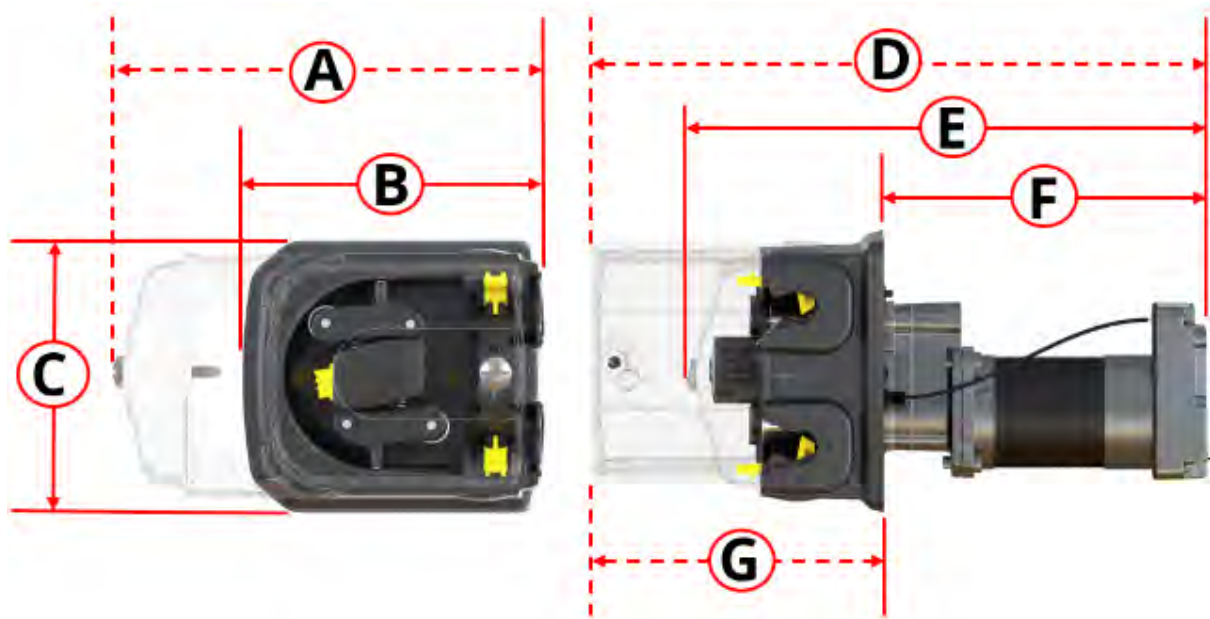

A		B		C		D		E		F		G	
mm	in	mm	in	mm	in	mm	in	mm	in	mm	in	mm	in
212	8.35	150	5.91	132	5.20	318	12.52	260	10.24	161	6.34	157	6.18

4.9.6.9 Weight: 100 Series

	with 1 m cables ¹		with 3 m cables ¹	
	kg	lbs	kg	lbs
Drive only (all models)	0.6	1.323	0.7	1.543
Complete pump (all models)	0.8	1.764	0.9	1.984

NOTE 1

In addition to the power cable, an ADC model is supplied with a control cable of the same length. En and Pn models are not supplied with a control cable.

4.9.6.10 Weight: 300 Series

	Models with: Standard NEMA 24 Stepper motor			
	with 1 m cables ¹		with 3 m cables ¹	
	kg	lbs	kg	lbs
Drive only (all models)	1.3	2.866	1.4	3.086
Complete pump (all models)	1.7	3.748	1.8	3.968

	Models with: High Torque NEMA 24 Stepper motor			
	with 1 m cables ¹		with 3 m cables ¹	
	kg	lbs	kg	lbs
Drive only (all models)	1.9	4.189	2.0	4.409
Complete pump (all models)	2.3	5.071	2.4	5.291

NOTE 1

In addition to the power cable, an ADC model is supplied with a control cable of the same length. En and Pn models are not supplied with a control cable.

4.9.6.11 Weight: 400 Series

	with 1 m cables ¹		with 3 m cables ¹	
	kg	lbs	kg	lbs
Drive only (all models)	1.1	2.425	1.2	2.646
Complete pump (all models)	1.8	3.968	1.9	4.189

NOTE 1

In addition to the power cable, an ADC model is supplied with a control cable of the same length. En and Pn models are not supplied with a control cable.

4.9.6.12 Weight: 500 Series

	with 1 m cables ¹		with 3 m cables ¹	
	kg	lbs	kg	lbs
Drive only (all models)	1.7	3.748	1.8	3.968
Complete pump (all models)	2.9	6.393	3.0	6.614

NOTE 1

In addition to the power cable, an ADC model is supplied with a control cable of the same length. En and Pn models are not supplied with a control cable.

4.9.7 Electrical power specification

The power supply specifications are provided in the table below.

Parameter	Limits			Units	Comment
	Min	Nom	Max		
Absolute maximum input voltage range	0		60	V DC	
Operational input voltage range	10.8		52.8	V DC	12 V \pm 10 % to 48 V \pm 10 %
Recommended input voltage range	12	24	48	V DC	
Rated power			75	W	
Overvoltage category		I			

NOTICE

Voltage beyond the 'absolute maximum input voltage range' (0 V to 60 V DC) may cause permanent damage to the device. Do not provide a voltage to the device outside of this range.

5 Storage

5.1 Storage conditions

A DriveSure pump or tubing should be stored in accordance with the information in this table:

Name	Specification
Ambient temperature range	- 20 °C to 70 °C (-4 °F to 158 °F)
Humidity (non-condensing)	80 % up to 31 °C (88 °F), decreasing linearly to 50 % at 40 °C (104 °F)
Conditions	Not in direct sunlight
Location	Indoor

5.2 Tubing and element shelf life from date of manufacture

Product	Shelf life ¹
Pumpsil	5 years
Marprene	5 years
Bioprene	5 years
PureWeld XL	5 years
STA-PURE PCS	4 years
STA-PURE PFL	4 years

NOTE 1

The shelf life is incorporated into the use by date provided (in reverse date order) on the label fixed to the product packaging.



6 Unpacking

6.1 Components supplied

The pump is supplied with the following items:

- Pump¹
- Power cable
- Control cable (DriveSure ADC only)²
- Safety information booklet (with link to these instructions)
- Pump mounting bolts

NOTE 1

The 300 Series, 400 Series and 500 Series pumps are supplied with the pumphead mounted to the drive unit. For installation reasons, the 100 Series pumps are supplied with the pumphead, mounting plate and drive unit unassembled.

NOTE 2

A control cable is supplied with a DriveSureADC pump only. EtherNet/IP and PROFINET control cables are available as optional accessories.

6.2 Unpacking, inspection, and packaging disposal

1. Carefully remove all parts from the packaging.
2. Check that all components are present.
3. Inspect components for damage in transit.
4. If anything is missing or damaged, contact your Watson-Marlow representative immediately.
5. Dispose of the cardboard packaging according to local procedures.

7 Installation chapter overview

7.1 Installation chapter sequence

Installation is provided in the following sequence:

1. Installation—Chapter 1: Physical (See page 50)
2. Installation—Chapter 2: Electrical Power (See page 71)
3. Installation—Chapter 3 Overview: Remote Control(See page 75)

The remote-control chapter is further divided into the following sub chapters:

- Installation—Sub-Chapter 3A: Remote Control: DriveSure ADC (See page 76)
- Installation—Sub-Chapter 3B: Remote Control: DriveSure En (See page 82)
- Installation—Sub-Chapter 3B: Remote Control: DriveSure Pn (See page 94)
4. Installation—Chapter 4: Local control (See page 106)
 - Integrated cover-open sensor
 - Prime switch
5. Installation—Chapter 5: Fluid path(See page 112)

Follow the installation in the specific sequence above—The instructions have been written in the order above, to minimise particular hazards.

7.2 Installation chapter structure

Each of the installation chapters are divided into two main parts in the sequence below, such that chapter requirements are placed prior to installation procedures.

1. Part 1: Installation requirements, specification, and information for the chapter
2. Part 2: Installation procedures for the chapter

8 Installation—Chapter 1: Physical

8.1 Part 1: Chapter installation requirements, specification, and installation

8.1.1 Intended mounting

The pump is designed for installation through in a panel to separate the environment of the pumphead from that of the drive unit. The panel is represented by the red outline in the image below.

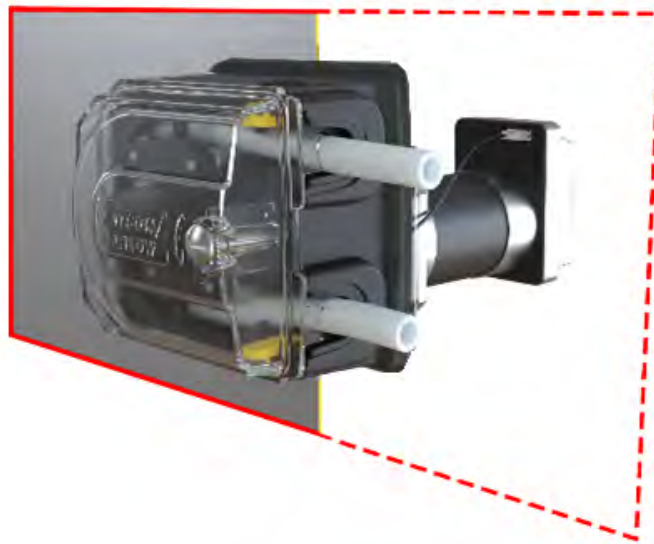

8.1.1.1 Panel thickness

Mounting plate and fixing bolts have been designed to the following panel thickness:

	Unit	
	mm	In
Minimum panel thickness	1.5	0.059
Maximum panel thickness	3.0	0.118

This is to ensure sealing between the mounting plate and the panel. Panels outside of this should be assessed for overall mounting and sealing, such as mounting bolt length and mounting plate size/support.

8.1.1.2 Surface characteristics

The panel which the pump will be mounted to must be:

- Rigid
- Flat
- Chemically compatible with the pumped fluid
- Capable of supporting the product weight including the full fluid path
- Free from excessive vibration

8.1.2 Intended environment

Name	Specification
Ambient temperature range	5 °C to 40 °C (41 °F to 104 °F)
Humidity (non-condensing)	80 % up to 31 °C (88 °F), decreasing linearly to 50 % at 40 °C (104 °F)
Maximum altitude	2,000 m, (6,560 ft)
Pollution degree of the intended environment	2
Location	Indoor

8.1.2.1 Ingress protection

100, 300 and 500 series DriveSure models are capable of passing an IP66 test when mounted in a suitable enclosure. In isolation, these models do not have an Ingress Protection (IP) rating.

400 RXMD DriveSure 400 series models require additional measures to achieve an IP rating.

For more information contact your Watson-Marlow representative.

8.1.3 Area around the product

8.1.3.1 Minimum area 100 Series

The following minimum area is required:

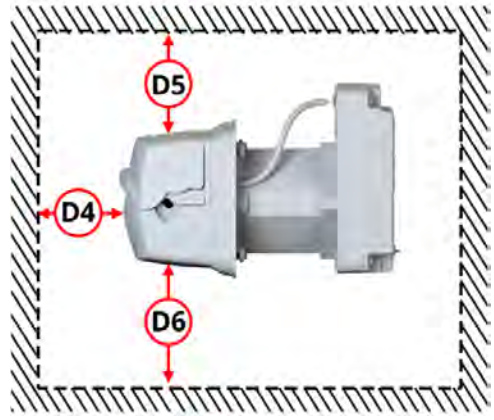
Top view		Side view	
			
Dimension	Minimum clearance		Comment
	mm	in	
D1	175	6.89	To install drive, cable connections, and protect cable bend radius,
D2	100	3.94	To install or replace the tubing/fluid path connections
D3	300	11.81	To install or replace the tubing/fluid path connections
D4	500	19.69	To install and replace the tubing inside pumphead
D5	100	3.94	To allow the pumphead cover to be opened and allow the pump to be installed through the panel aperture, by turning or tipping the pump as necessary
D6	100	3.94	To allow the pump to be installed through the panel aperture, by turning or tipping the pump as necessary

It may be necessary to increase these minimum dimensions in a user's installation to:

- Ensure there is enough space to connect a USB cable
- To view the status LEDs on the controller and connection ports
- To access the drive labels (MAC address, etc)
- To ensure the drive will not exceed its ambient temperature and humidity range
- For installation of non-Watson-Marlow products (control cables, etc)

8.1.3.2 Minimum area 300 Series

The following minimum area is required:

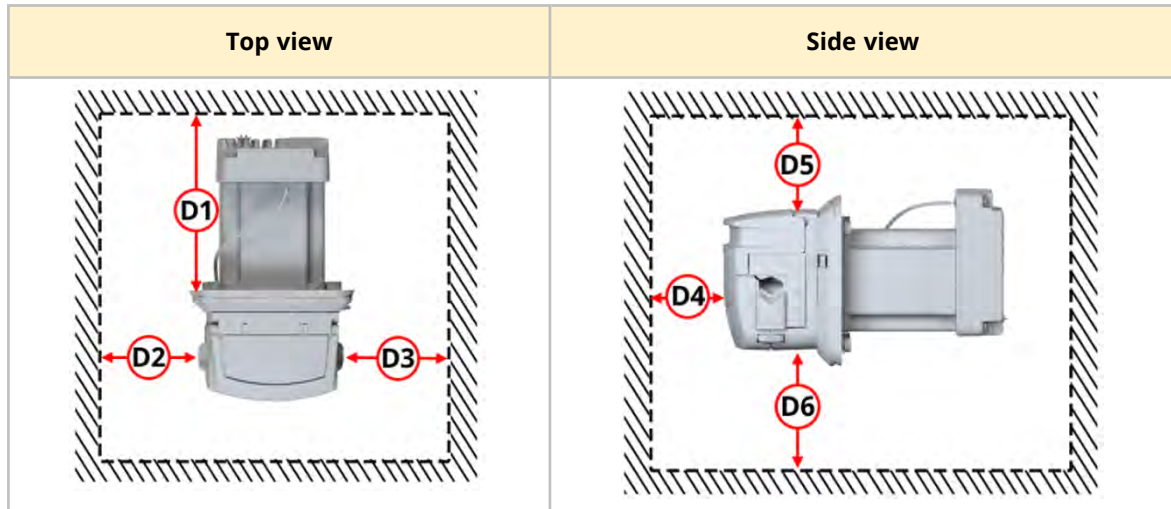

Dimension	Minimum clearance		Comment
	mm	in	
D1	175	6.89	To install drive, cable connections, and protect cable bend radius,
D2	100	3.94	To install or replace the tubing/fluid path connections
D3	300	11.81	To install or replace the tubing/fluid path connections
D4	500	19.69	To install and replace the tubing inside pumphead
D5	100	3.94	To allow the pumphead cover to be opened and allow the pump to be installed through the panel aperture, by turning or tipping the pump as necessary
D6	100	3.94	To allow the pump to be installed through the panel aperture, by turning or tipping the pump as necessary

It may be necessary to increase these minimum dimensions in a user's installation to:

- Ensure there is enough space to connect a USB cable
- For access to the drive to view the status LEDs on the controller and connection ports
- To access the drive labels (MAC address, etc)
- To ensure the drive will not exceed its ambient temperature and humidity range
- For installation of non-Watson-Marlow products (control cables, etc)

8.1.3.3 Minimum area 400 Series

The following minimum area provided in the table below is required:

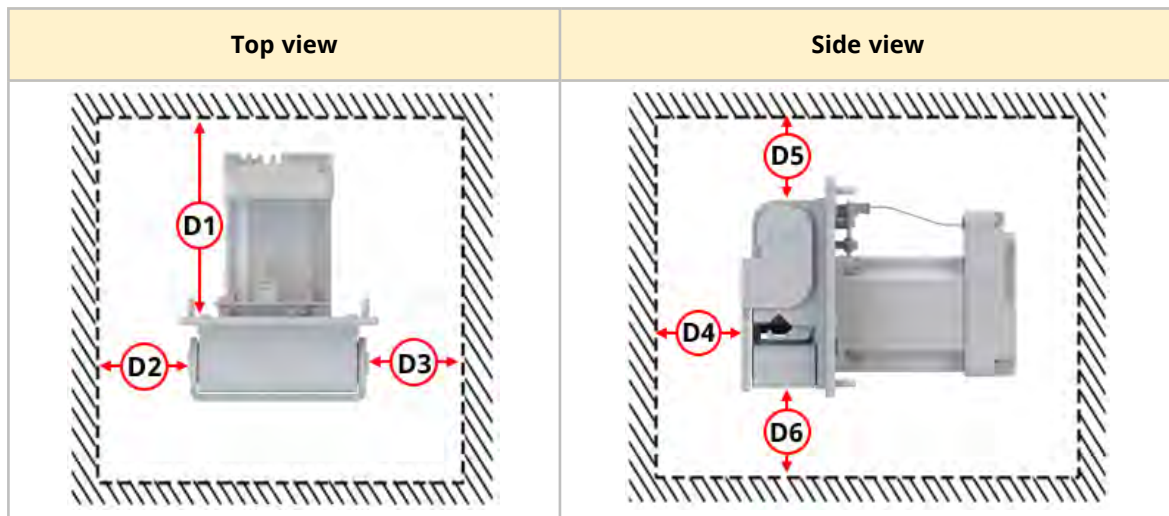

Dimension	Minimum clearance		Comment
	mm	in	
D1	175	6.89	To install drive, cable connections, and protect cable bend radius,
D2	100	3.94	To allow the pumphead cover to be opened
D3	300	11.81	To install or replace the tubing/element fluid path connections
D4	500	19.69	To install and replace the tubing/element inside pumphead
D5	100	3.94	To allow the pump to be installed through the panel aperture, by turning or tipping the pump as necessary
D6	100	3.94	To allow the pump to be installed through the panel aperture, by turning or tipping the pump as necessary

It may be necessary to increase these minimum dimensions in a user's installation to:

- Ensure there is enough space to connect a USB cable
- To view the status LEDs on the controller and connection ports
- To access the drive labels (MAC address, etc)
- To ensure the drive will not exceed its ambient temperature and humidity range
- For installation of non-Watson-Marlow products (control cables, etc)

8.1.3.4 Minimum area 500 Series

The following minimum area is required:

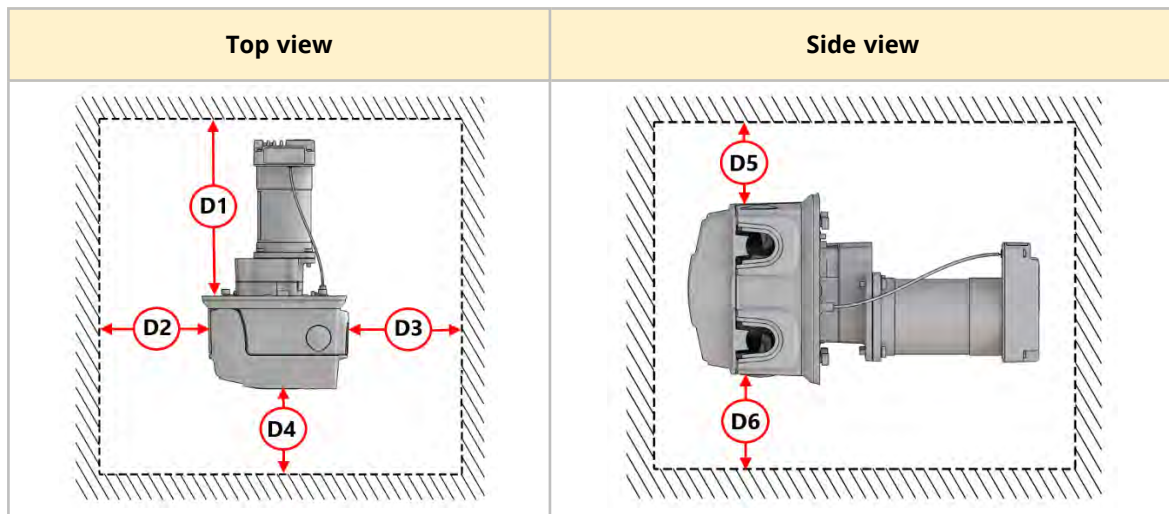

Dimension	Minimum clearance		Comment
	mm	in	
D1	200	7.87	To install drive, cable connections, and protect cable bend radius,
D2	100	3.94	To allow the pumphead cover to be opened
D3	300	11.81	To install or replace the tubing/element fluid path connections
D4	500	19.69	To install and replace the tubing/element inside pumphead
D5	100	3.94	To allow the pump to be installed through the panel aperture, by turning or tipping the pump as necessary
D6	100	3.94	To allow the pump to be installed through the panel aperture, by turning or tipping the pump as necessary

It may be necessary to increase these minimum dimensions in a user's installation to:

- Ensure there is enough space to connect a USB cable
- To view the status LEDs on the controller and connection ports
- To access the drive labels (MAC address, etc)
- To ensure the drive will not exceed its ambient temperature and humidity range
- For installation of non-Watson-Marlow products (control cables, etc)

8.1.3.5 Access for inspection

The pump must be installed allowing access for possible inspection or further installation by other responsible persons prior to operation:

- Power cable
- Control cable
- Integrated cover-open sensor cable
- Prime switch
- USB connection
- Status LEDs

8.1.4 Panel mounting dimensions (100 Series)

8.1.4.1 Mounting bolt holes (100 Series)

The mounting bolt holes must be prepared in the panel prior to pump installation, using the dimensions below.:

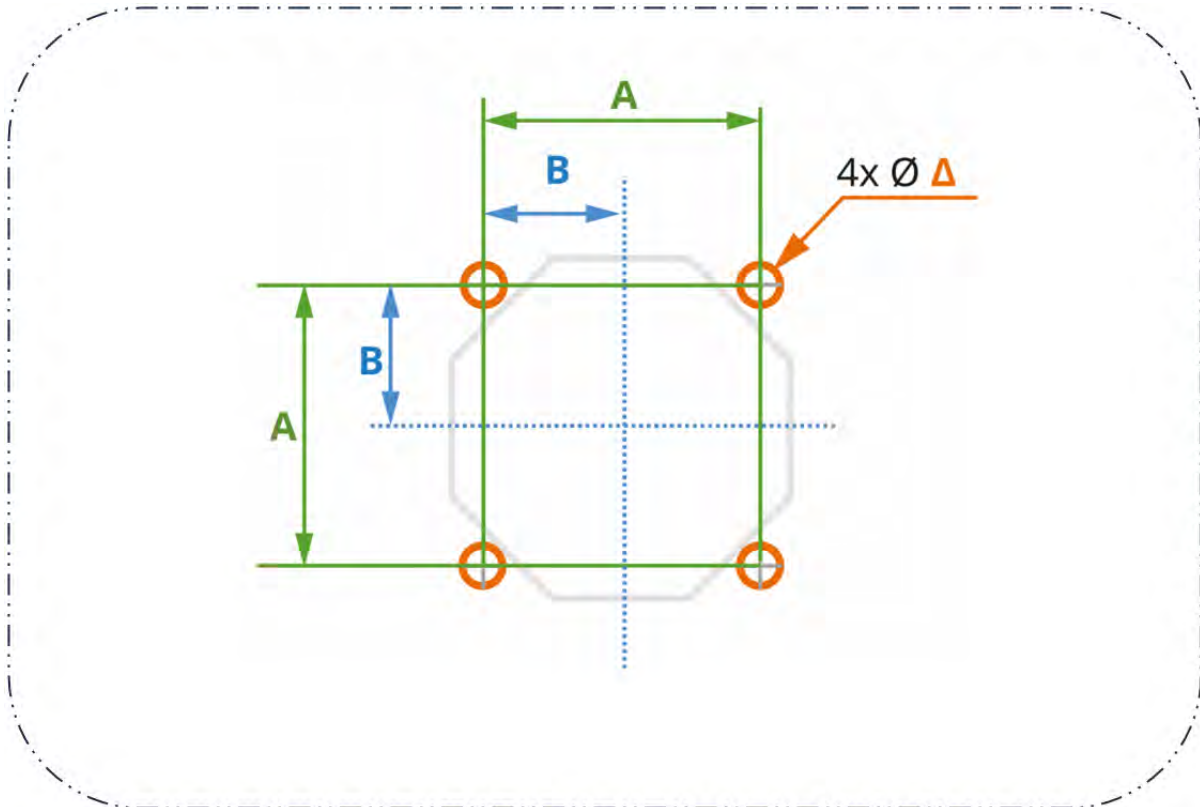

Dimension	Unit	
	mm	in
A	48	1.89
B	24	0.94
Δ	5	0.20

8.1.4.2 Panel aperture dimensions for 100 Series

The required dimension of the aperture are provided in the image below. The 8 holes at the intersection of C and D (Ω) are provided to aid manual cutting of the aperture.

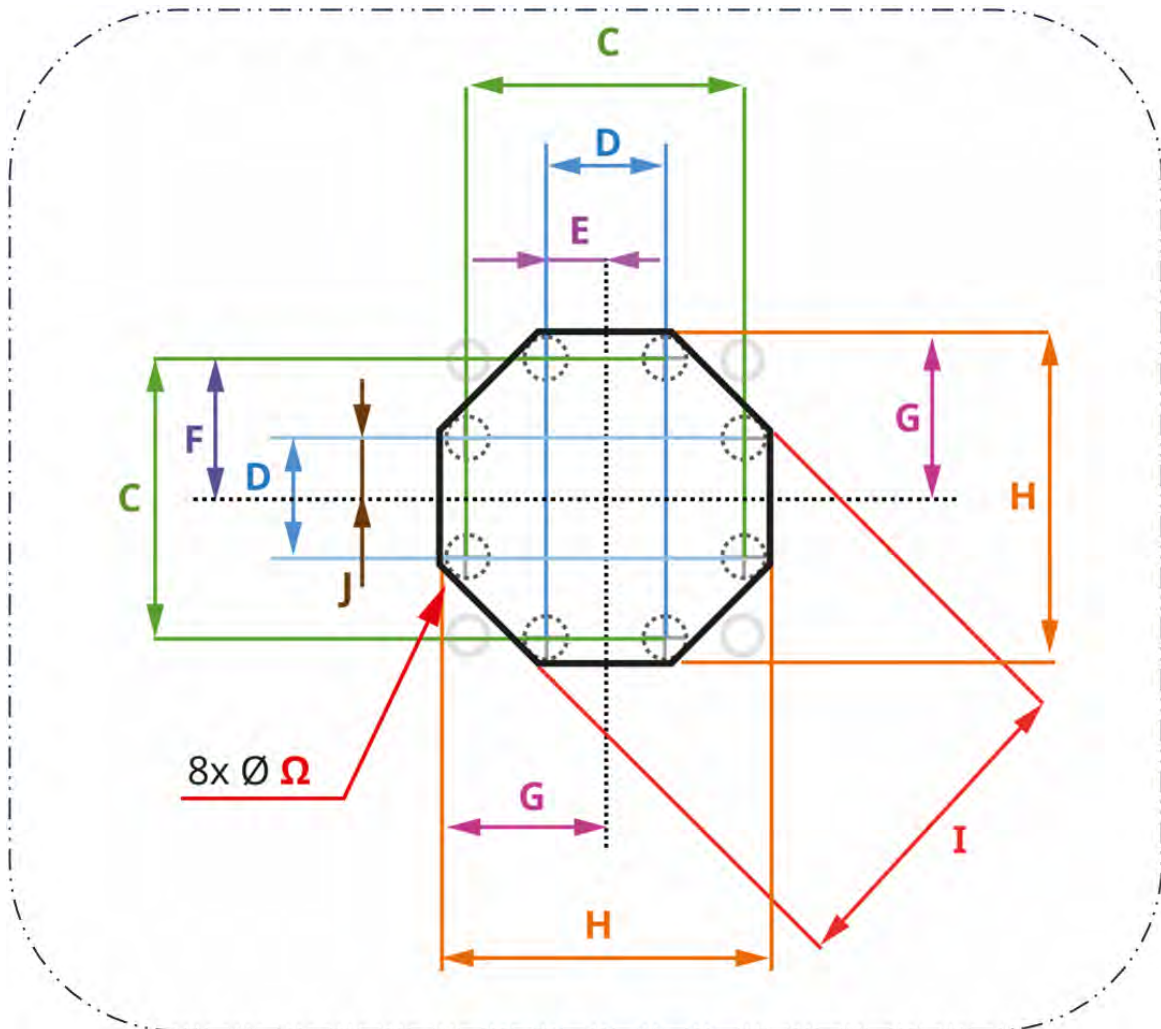

Dimension	mm	in
C	49	1.93
D	21	0.83
E	10.5	0.413
F	24.5	0.965
G	27.5	1.08
H	55	2.17
I	55.25	2.1752
Ω	6	0.24

8.1.5 Panel mounting dimensions (300 Series)

8.1.5.1 Mounting bolt holes(300 Series)

The mounting bolt holes must be prepared in the panel prior to pump installation, using the dimensions below:

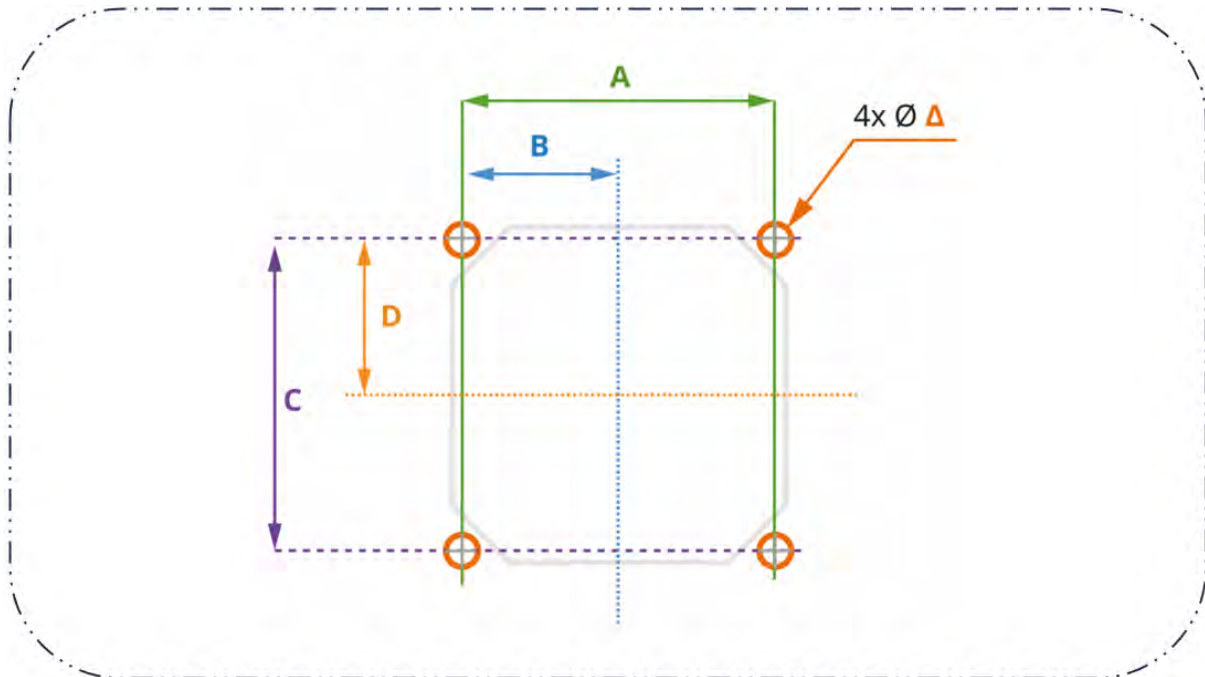

Dimension	Unit	
	mm	in
A	69.6	2.740
B	34.8	1.370
C	69.6	2.740
D	34.8	1.370
Δ	5	0.20

8.1.5.2 Panel aperture dimensions for 300 Series

The required dimension of the aperture are provided in the image below. The 8 holes at the intersection of E and F (Ω) are provided to aid manual cutting of the aperture.

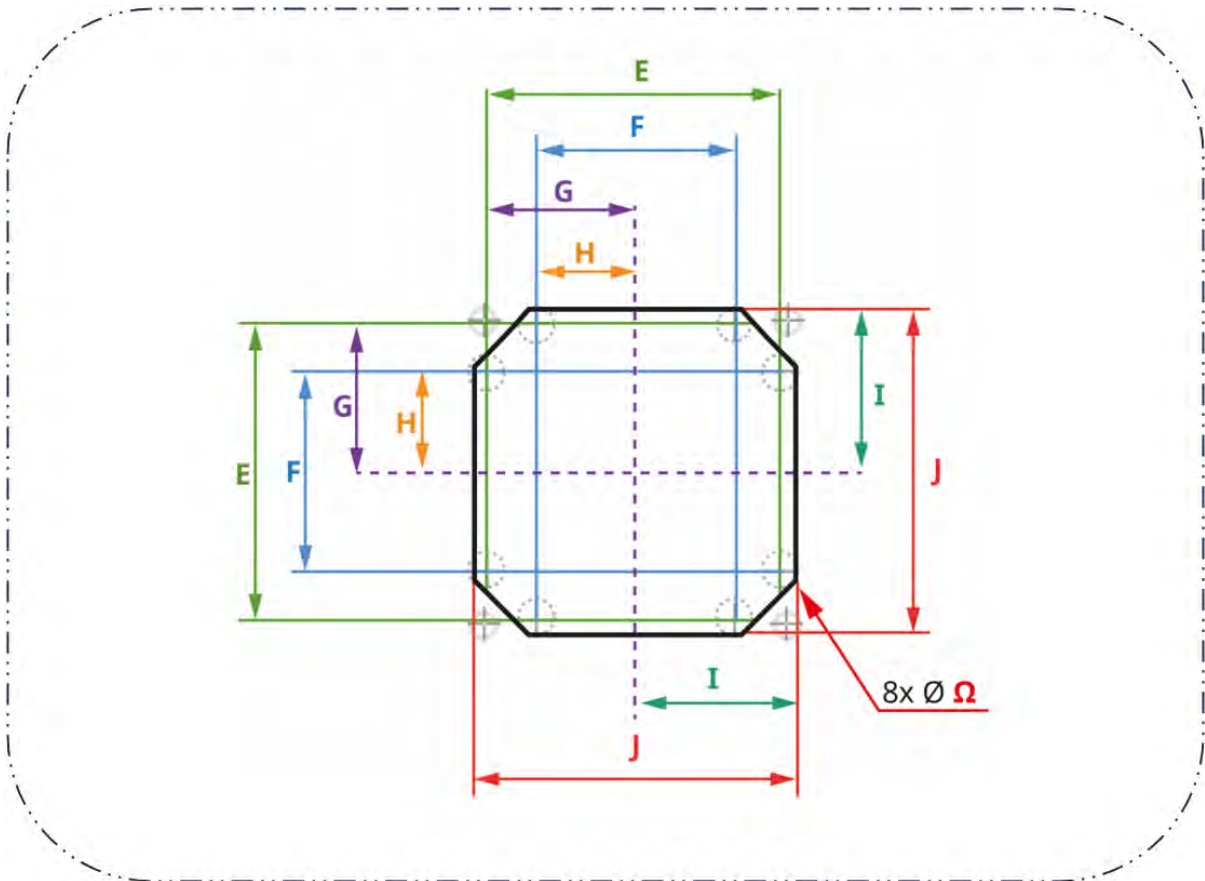

Dimension	Unit	
	mm	in
E	68	2.68
F	46	1.81
G	34	1.34
H	23	0.91
I	37	1.46
J	74	2.91
Ω	6	0.24

8.1.6 Panel mounting dimensions (400 Series)

8.1.6.1 Mounting bolt holes (400 Series)

The mounting bolt holes must be prepared in the panel prior to pump installation, using the dimensions below:

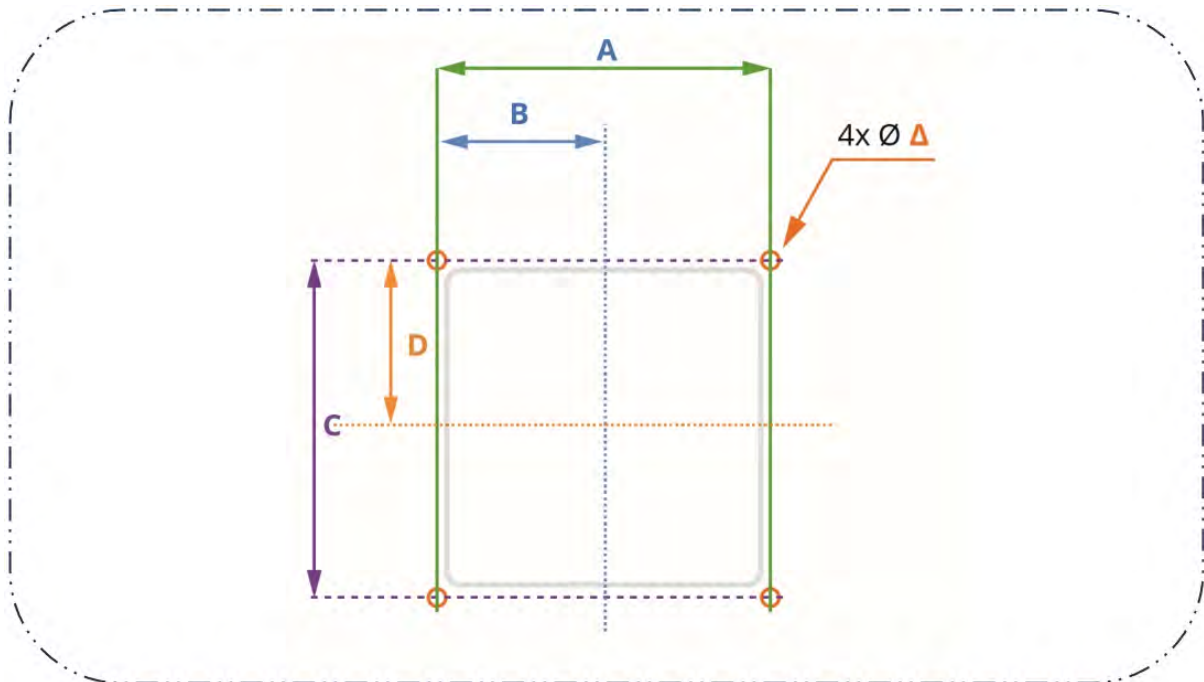

Dimension	Unit	
	mm	in
A	98	3.83
B	49	1.93
C	98	3.83
D	49	1.93
Δ	4.5	0.177

8.1.6.2 Panel aperture dimensions (400 series)

The required dimension of the aperture are provided in the image below. The 4 holes at the intersection of E and F (Ω) are provided to aid manual cutting of the aperture.

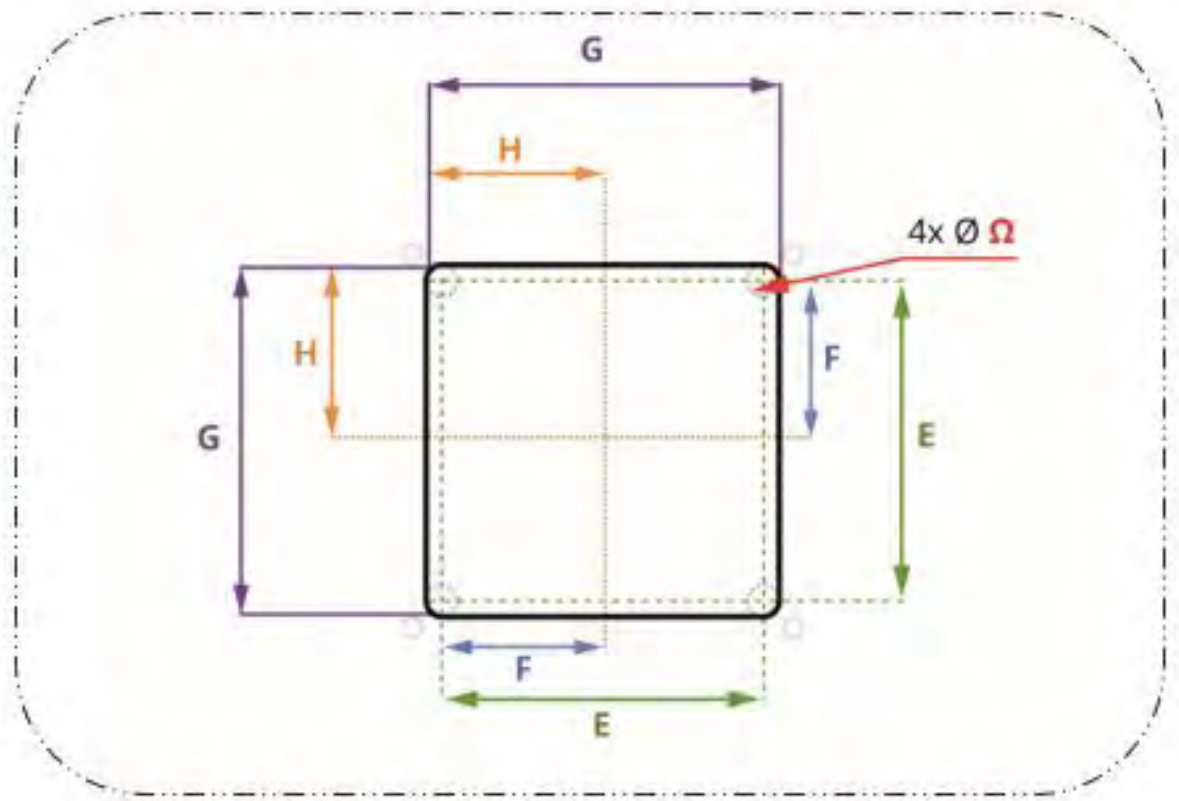

Dimension	Unit	
	mm	in
E	86	3.39
F	43	1.69
G	94	3.70
H	47	1.85
Ω	4	0.16

8.1.7 Panel mounting dimensions (500 Series)

8.1.7.1 Mounting bolt and alignment pin holes (500 Series)

In addition to mounting bolt holes, the 500 Series requires holes for the mounting plate alignment pins. These holes must be prepared in the panel prior to pump installation, using the dimensions below:

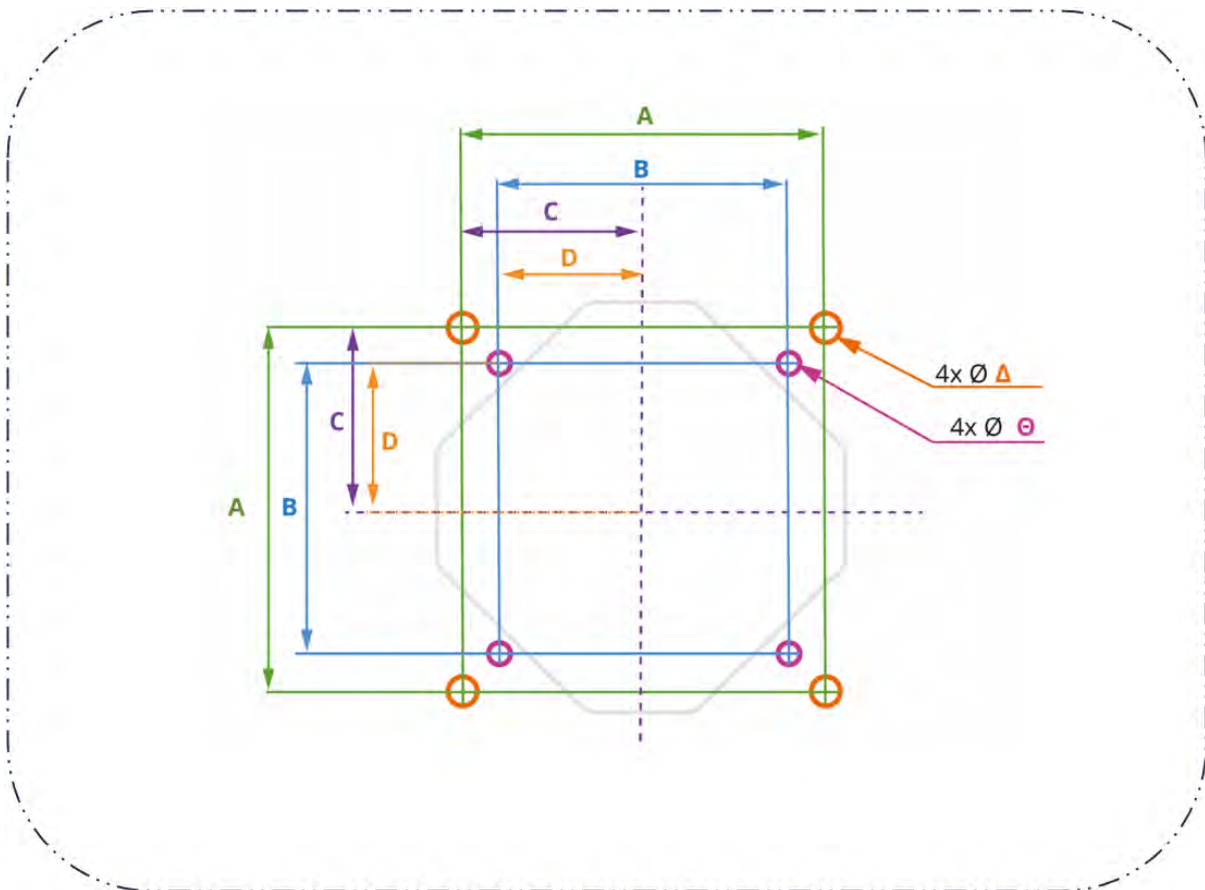

Dimension	Unit	
	mm	in
A	100	3.94
B	80	3.15
C	50	1.97
D	40	1.57
Δ	5	0.20
⊕	4	0.16

8.1.7.2 Panel aperture dimensions (500 Series)

The required dimension of the aperture is provided in the image below. The 8 holes at the intersection of E and F (Ω) are provided to aid manual cutting of the aperture.

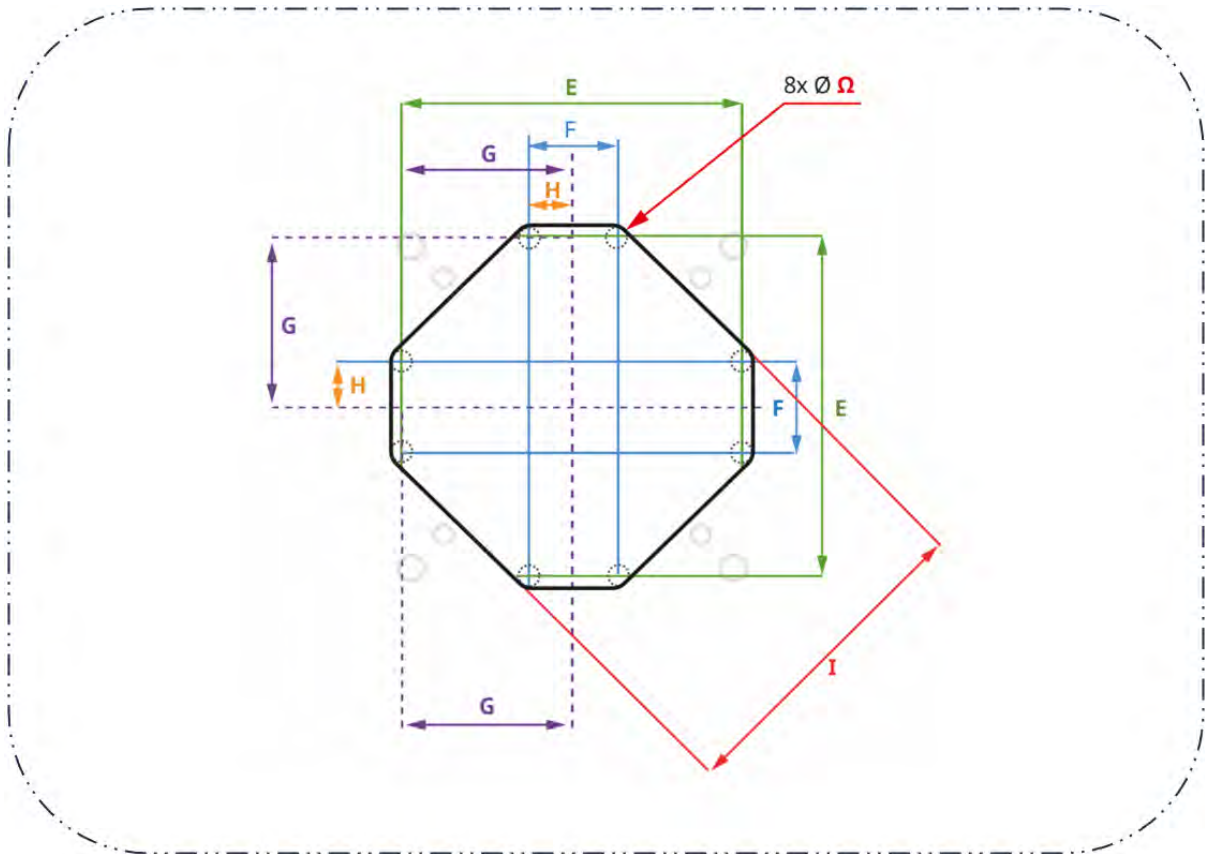

Dimension	Unit	
	mm	in
	106	4.17
F	28	1.10
G	53	2.09
H	14	0.55
I	101	3.98
Ω	6	0.24

8.1.8 Specific tools required for chapter installation procedures

To complete the installation procedures in this chapter, the following tools are required:

100 Series	300 Series	400 Series	500 Series
Torque wrench suitable for 4.6 Nm	Torque wrench suitable for 4.6 Nm	Torque wrench suitable for 4.6 Nm	Torque wrench suitable for 5.5 Nm
T15 and T20 male Torx bit	T25 male Torx bit		T25 male Torx bit
Flat head screwdriver			Flat head screwdriver

8.2 Part 2: Chapter installation procedures

8.2.1 Chapter pre-installation checklist

Carry out the following pre-installation checklist prior to following the installation procedure below to ensure:

- All requirements of part 1 of this chapter have been met
- Panel mounting is ready (aperture, pump mounting holes, alignment pin holes)
- The 4-drive mounting cap screw bolts (supplied with the pump) are to hand
- Drive is not connected to electrical power, control cables or the fluid path. The installation of these items is provided in subsequent chapters.

If there is a problem with any of the pre-installation checklist items, do not proceed to the installation procedures in this chapter, until the matter is resolved.

8.2.2 Procedure: Mounting the pump

The 100 Series and 300 Series, 400 Series and 500 Series are mounted differently.

- The 100 Series is mounted in parts, with the pumphead mounting plate being mounted to the aperture, followed by the drive and pumphead in separate steps.
- The 300 Series, 400 Series and 500 Series are mounted by passing the drive end of the pump through the panel aperture, with the pumphead already pre-installed on the pump during Watson-Marlow production.

8.2.2.1 100 Series mounting

1. Complete the chapter pre-installation checklist.
2. Attach mounting to panel with 4 mounting plate bolts.



3. Check the integrated cover-open sensor cable is not trapped or touching the edge of the aperture.
4. Torque the 4 mounting plate bolts using an alternating pattern to 4.6 Nm.
5. Attach drive to mounting using the 4 drive mounting bolts.
6. Torque the 4 drive mounting bolts using an alternating pattern to 4.6 Nm.



7. Attach pumphead to mounting using the 2 pumphead mounting bolts.
8. Torque the 2 pumphead mounting bolts, to 4.6 Nm.



9. Plug pumphead integrated cover-open sensor cable into the back of the controller.



8.2.2.2 300 Series mounting

1. Complete the chapter pre-installation checklist.
2. Pass the controller end of the pump through the aperture in the panel, until the pumphed mounting plate sits against the panel.



3. Install 4 mounting bolts hand tight.
4. Check the integrated cover-open sensor cable is not trapped or touching the edge of the aperture.



5. Torque the 4 mounting bolts using an alternating pattern to 4.6 Nm.
6. Check the pumphed mounting plate is evenly pressed against the pumphed side of the panel, with no visible gap.

8.2.2.3 400 Series mounting

1. Complete the chapter pre-installation checklist.
2. Pass the controller end of the pump through the aperture in the panel, until the pumphead mounting plate sits against the panel.



3. Install 4 mounting bolts hand tight.
4. Check the integrated cover-open sensor cable is not trapped or touching the edge of the aperture.

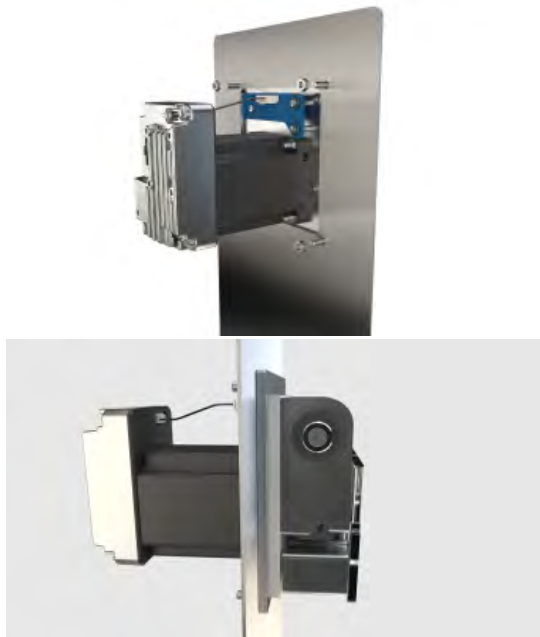

5. Torque the 4 mounting bolts using an alternating pattern to 4.6 Nm.
6. Check the pumphead mounting plate is pressed against the pumphead side of the panel, with no visible gap.

8.2.2.4 500 Series mounting

1. Complete the chapter pre-installation checklist.

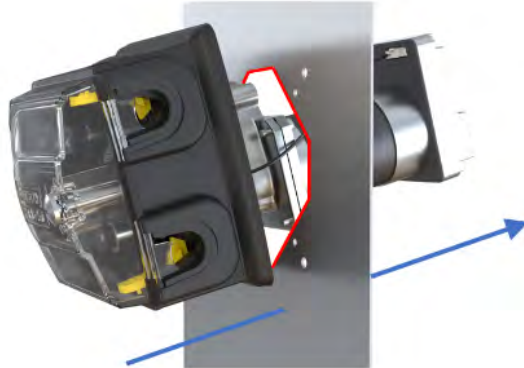

2. Pass the controller end of the pump through the aperture in the panel, until the pumphead engages the pre-drilled alignment pin holes.
3. Install the 4 mounting bolts hand tight.
4. Check the integrated cover-open sensor cable is not trapped or touching the edge of the aperture.
5. Torque the 4 mounting bolts using an alternating pattern to 5.5 Nm
6. Check the pumphead mounting plate is evenly pressed against the pumphead side of the panel, with no visible gap.

9 Installation—Chapter 2: Electrical power

9.1 Part 1: Chapter installation requirements, specification, and information

9.1.1 Electrical power supply requirements

The pump requires electrical power by Direct Current (DC) within the following specification:

Parameter	Limits			Units	Comment
	Min	Nom	Max		
Absolute maximum input voltage range	0		60	V DC	
Operational input voltage range	10.8		52.8	V DC	12 V±10% to 48 V±10%
Recommended input voltage range	12	24	48	V DC	
Rated power			75	W	
Overvoltage category		I			

NOTICE

Voltage beyond the 'absolute maximum input voltage range' (0 to 60 VDC) may cause permanent damage to the device. Do not provide a voltage to the device outside of this range.

9.1.1.1 Power cable specification

The pump is supplied with a power cable of the following specification:

Item	Specification
Length	1 m (3.28 ft) or 3.0 m (9.84 ft)
Wiring	2 core screened red/black 22 AWG 300 V VW-1 ALPHA WIRE 2402C SL005 UL STYLE 2092
Connection (controller end)	Power connector to controller installed on cable, with black wire on left for negative DC (-), and red wire on right for (+) DC

9.1.1.2 Power cable wiring: Polarity

The controller does not have polarity protection. The black wire of the Watson-Marlow power cable must only be connected to negative (-) DC voltage.

The Watson-Marlow power cable is designed to connect to the controller as illustrated below:

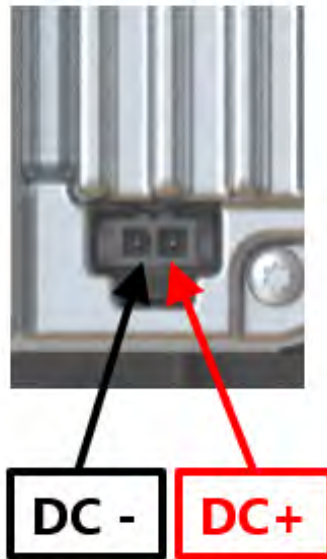

9.1.2 External devices

9.1.2.1 Overcurrent protection

The DriveSure pump has comprehensive software control of a robust motor drive to auto detect and shut down the pump safely because of overloading, or over-temperature.

An external fuse is required with the following specifications:

Protective component	Power supply		Approvals	Comment
	12 to 24 V DC	25 to 48 V DC		
Fuse	T 5 A H 250V	T 3.15 A H 250V	UL Category Control Number: JDYX/JDYX2 IEC 60127	T = Time Delay H = High Breaking Capacity
Fuse holder	-	-	UL Category Control Number: IYXV/IYXV2, IEC 60695-11-10 min V-1 flammability	-

9.1.2.2 In-rush current protection

The pump is not designed such that a live power supply cable may be connected to the DriveSure pump. This restraint also applies to a DC power supply connected through a relay.

Consider the use of in-rush current protection in your design if a hot-switch is required.

9.1.2.3 Electrical isolation

The product does not come with an external supply isolation device. An electrical power supply isolation device must be:

- Included in the electrical power supply circuit
- Be always easily accessible
- Marked as the disconnecting device for the equipment
- Of a rating suitable for the power specification

9.2 Part 2: Chapter installation procedures

9.2.1 Safety: Power cycling

Regular starting and stopping of the pump must be undertaken using control signals. Do not use electrical power as a method of regular starting and stopping of the pump; Electrical power is reserved as a method of stopping the pump in an emergency only.

9.2.2 Chapter pre-installation checklist

Prior to electrical power installation, carry out the following pre-installation check to ensure:

- Pump has been installed in accordance with installation chapter 1 (See page 50)
- All requirements of part 1 of this chapter have been met. (See page 71)
- Pumphead cover is closed
- Power cable is not damaged
- Integrated cover-open sensor cable is not damaged
- Fluid path to the pump has not yet been installed. (See page 112)

If there is a problem with any of the pre-installation checklist items, do not proceed to the installation procedures in this chapter, until the matter is resolved.

9.2.3 Procedure: Connecting to DC power

1. Complete the chapter pre-installation checklist
2. Isolate the power supply
3. Depress the retaining latch on the power cable connection
4. Push the power cable connection into the controller
5. Release the retaining latch
6. Check the power cable is securely connected to the controller
7. Turn on the power supply

NOTICE

Turn on the power supply only after the cable is securely connected – do not 'hot plug' the power cable into a DriveSure pump, doing so may damage the internal circuitry reaches the applied voltage.

10 Installation—Chapter 3 Overview: Remote Control

On the remote-control chapter, follow the sub-chapter based upon your model:

- Sub-Chapter 3A: Remote Control: DriveSure ADC ([See page 76](#))
- Sub-Chapter 3B: Remote Control: DriveSure En ([See page 82](#))
- Sub-Chapter 3C: Remote Control: DriveSure Pn ([See page 94](#))

11 Installation—Sub-Chapter 3A: Remote Control: DriveSure ADC

This sub chapter details the remote control of an DriveSureADC pump.

11.1 Part 1: Sub-Chapter installation requirements, specification, and information

11.1.1 Connection and cable specification

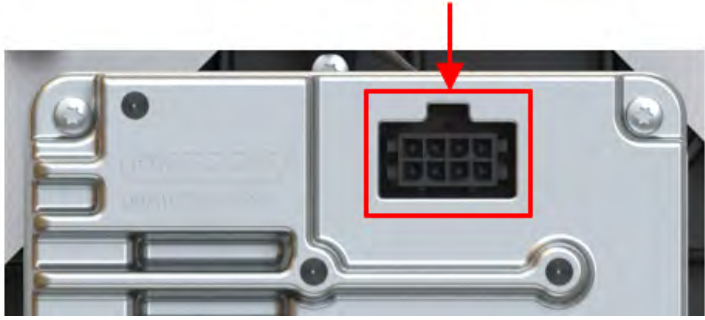
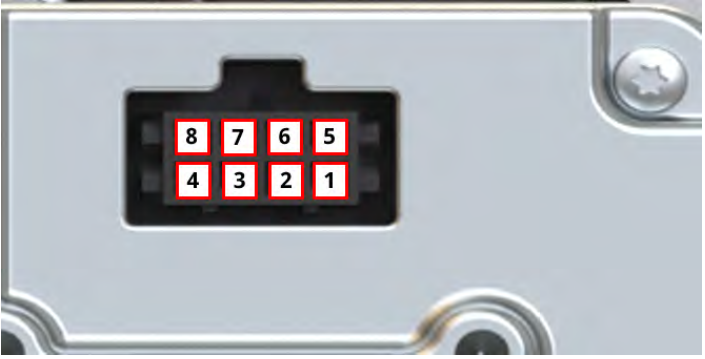
Item	Information
Location of control connection	
Connection on controller	FEMALE Molex, 8 wire, part number 43045-0813
Cable specification	MALE Molex Housing, 8 wire, part number 43025-0800, 8 CORE SCREENED, 24AWG 300V VW-1 ALPHA WIRE 1218C SL005, UL STYLE 2576
Connector pin order	

11.1.2 Galvanic isolation

The power input 0 V is internally connected to the Analogue control connector 0 V and USB-C 0 V. Avoid inadvertent ground (0 V) loops when connecting controllers or other equipment. Consider galvanic isolation if required.

11.1.3 Inputs and output: Overview

The following user interfaces are provided to allow the user to control the operation of the pump with limited status indication.

Pin number	Parameter Signal	Type	Input or output	Comment	Control cable wire colour
1	FAULT	Open drain	Output	The fault type ¹ is not signalled	Black
2	TACHO	Open drain	Output		Brown
3	DIRECTION	Digital	Input	Configuration determined, default 0=CW 1=CCW	Red
4	BRAKE/RUN	Digital	Input	Configuration determined, default 0= Stop 1= Run	Orange
5	0-10 V	Analogue	Input		Yellow
6	4-20 mA	Analogue	Input		Green
7	Signal GND				Blue
8	FREQUENCY	Digital	Input	Configuration determined	Violet

NOTE 1

There are 14 fault types, indicated through the number of status LED flashes (See page 79). The fault output does not provide the fault type, only the indication that a fault is present. The fault type can be determined by connecting to the WM Connect PC software.

11.1.4 Input and output: Limits

Do not exceed the input and output limits provided in the table below:

Parameter	Sym	Limits			Units	Comment
		Min	Nom	Max		
Digital Input voltage High	VD_{IH}	10.4		30	V	IEC 61131-2 Type 3
Digital Input Voltage Low	VD_{IL}	0		9.2		"
Digital Input Abs Max voltage	VD_{in}	-60		60	V	Non operational
Digital Input current Limit	ID_{in}		2.25		mA	IEC 61131-2 Type 3
Digital Frequency	F_{in}	2		2000	Hz	
4-20 mA input measurement range	I_{in}	0		25	mA	
4-20 mA input Abs Max Current	IA_{in}	-0.01		33	mA	Internally limited to max voltage
4-20 mA Input, Abs Max Voltage	Ia_{in}	-36		36	V	See above
4-20 mA Input resistance	RI_{in}		150	200	Ω	150R Sense Res.
0-10V input measurement range	V_{in}	0		10.56	V	
0-10V Input, Abs Max Voltage	VA_{in}	-36		36	V	
0-10V Input resistance	RV_{in}		20		K Ω	
Analogue input Temp Error	TC_A		± 0.04		%/C	
Open Drain Current	IL			1	A	Resistive load
Open Drain Voltage	V_{OH}		24	36	VDC	60V Abs Max

11.1.5 Status LED (Integrated controller)

The controller has a LED light which provides an indication of status and errors.



The behaviour of the status LED is explained below:

Status LED colour	Description	
No colour (off)	No power	
Green	Pumphead cover closed, normal operation	
Amber	Pumphead cover open	
Red, flashing	Flashes	Error
	1	Over Voltage
	2	Under Voltage
	3	Over Current
	4	Software
	5	Stall
	6	Over Temperature Warning
	7	Over Temperature Shutdown
	8	Inverter Vds Overcurrent
	9	Inverter Sense Amplifier Overcurrent
	10	Inverter Undervoltage Lockout
	11	Inverter Gate Drive
	12	Inverter Charge Pump Undervoltage
	13	Voltage Range
14	Speed	

11.1.6 Defaults

A DriveSure ADC pump is programmed with the following defaults. These defaults can be changed in the WM Connect PC software. (See page 131).

		Series			
		100	300	400	500
Current	Max speed (rpm)	410	410	550	220
	Min speed (rpm)	0			
	Max input (mA)	20			
	Min input (mA)	4			
	Filter sample counts	16			
Voltage	Max speed (rpm)	410	410	550	220
	Min speed (rpm)	0			
	Max input (V)	10			
	Min input (V)	0.1			
	Filter sample counts	16			
Frequency	Max speed (rpm)	410	410	550	220
	Min speed (rpm)	0			
	Max input (Hz)	2000			
	Min input (Hz)	2			
Fixed speed	Speed (rpm)	100			

11.2 Part 2: Sub-Chapter installation procedures

11.2.1 Sub-Chapter pre-installation checklist

Prior to installing the control cable carry out the following pre-installation check. Make sure that:

- Pump has been installed in accordance with installation chapter 1 and 2.
- All requirements of part 1 of this chapter have been met:
- Power cable is not damaged
- Control cable is not damaged
- Integrated cover-open sensor cable is not damaged
- Pumphead cover is closed
- Fluid path to the pump has not yet been installed: ([See page 112](#))

If there is a problem with any of the pre-installation checklist items, do not proceed to the installation procedures in this chapter, until the matter is resolved.

11.2.2 Procedure: Connect the ADC control cable

1. Complete the pre-installation checklist
2. Isolate the pump from its power supply
3. Push the control cable into the control cable connection until an audible click is heard
4. Re-connect the power supply to the pump
5. Observe the status LED on the controller
6. Ensure the pump operates in accordance with the control system design (wiring and signals).

12 Installation—Sub-Chapter 3B: Remote Control: DriveSure En

This sub chapter details the remote control of a DriveSure En pump for EtherNet/IP control.

12.1 Part 1: Sub-Chapter installation requirements, specification, and information

12.1.1 Specific responsible person

All EtherNet/IP systems must be installed or certified by an EtherNet/IP approved installation engineer.

12.1.2 Network parameters

The network parameters for communication of the pump with the network, are pre-programmed during production:

Parameter	Address
IP Address	0.0.0.0
Subnet mask	0.0.0.0
Default gateway	0.0.0.0
DCHP	Enabled

These network parameters can be manually configured or the DHCP disabled (automatic IP address), using either the network PC software or WM Connect PC software ((See page 131)).

12.1.3 EDS File

The EDS file may be downloaded from the Watson-Marlow website from the link below:

Web address: <https://www.wmfts.com/en/literature/other-resources/software-and-devices/>

12.1.4 Network control connection location

The location of the network control cable connection) is provided below:

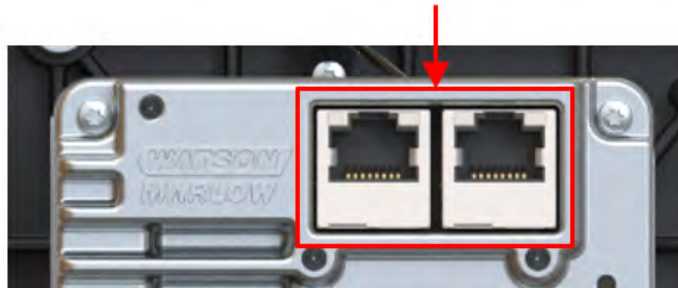

12.1.5 Network control cable specification

A category 5e, shielded ethernet cable, with a male RJ45 connector is required to connect and control a DriveSureEn drive.

12.1.6 Status LEDs (control cable connections)

The network control cable connections have status LEDs as detailed below.

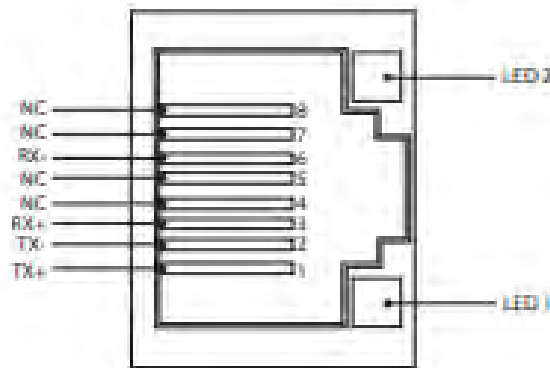

LED 1	LED 2	Indication
Low	Low	Off
Low	High	Yellow LED on for link detected, flickers to indicate 10 Mbit activity
High	Low	One green LED on for link detected, flickers to indicate 100 Mbit activity

12.1.7 Status LEDs (Integrated controller)

The controller has LEDs which provide an indication of status and errors.

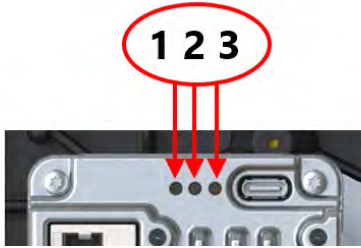
LED number	LED function	Picture showing LED number
LED 1	Module status	
LED 2	Network status	
LED 3	Drive status	

The behaviour of the LEDs is explained below.

12.1.7.1 LED 1: Module Status

LED Colour	Description
No colour (off)	No power
Green	Controlled by a scanner in run state and, if CIP sync is enabled, time is synchronised to a grandmaster clock
Green, flashing	Not configured, scanner in idle state, or, if CIP sync is enabled, time is synchronised grandmaster clock
Red	Major fault (EXCEPTION-state, FATAL error, etc)
Red, flashing	Recoverable faults(s). Module is configured, but stored parameters differ from currently used parameters

12.1.7.2 LED 2: Network status

LED Colour	Description
No colour (off)	No power, or no IP address
Green	Online, one or more connections established (CIP class 1 or 3)
Green, flashing	Online, no connections established
Red	Duplicate IP address, FATAL error
Red, flashing	One or more connections timed out (CIP class 1 or 3)

12.1.7.3 LED 3: Drive status

Status LED colour	Description	
No colour (off)	No power	
Green	Pumphead cover closed, normal operation	
Amber	Pumphead cover open	
Red, flashing	Flashes	Error
	1	Over Voltage
	2	Under Voltage
	3	Over Current
	4	Software
	5	Stall
	6	Over Temperature Warning
	7	Over Temperature Shutdown
	8	Inverter Vds Overcurrent
	9	Inverter Sense Amplifier Overcurrent
	10	Inverter Undervoltage Lockout
	11	Inverter Gate Drive
	12	Inverter Charge Pump Undervoltage
	13	Voltage Range
14	Speed	

12.1.8 Network arrangement

A DriveSureEn pump may be connected in any of the following 3 network arrangements.

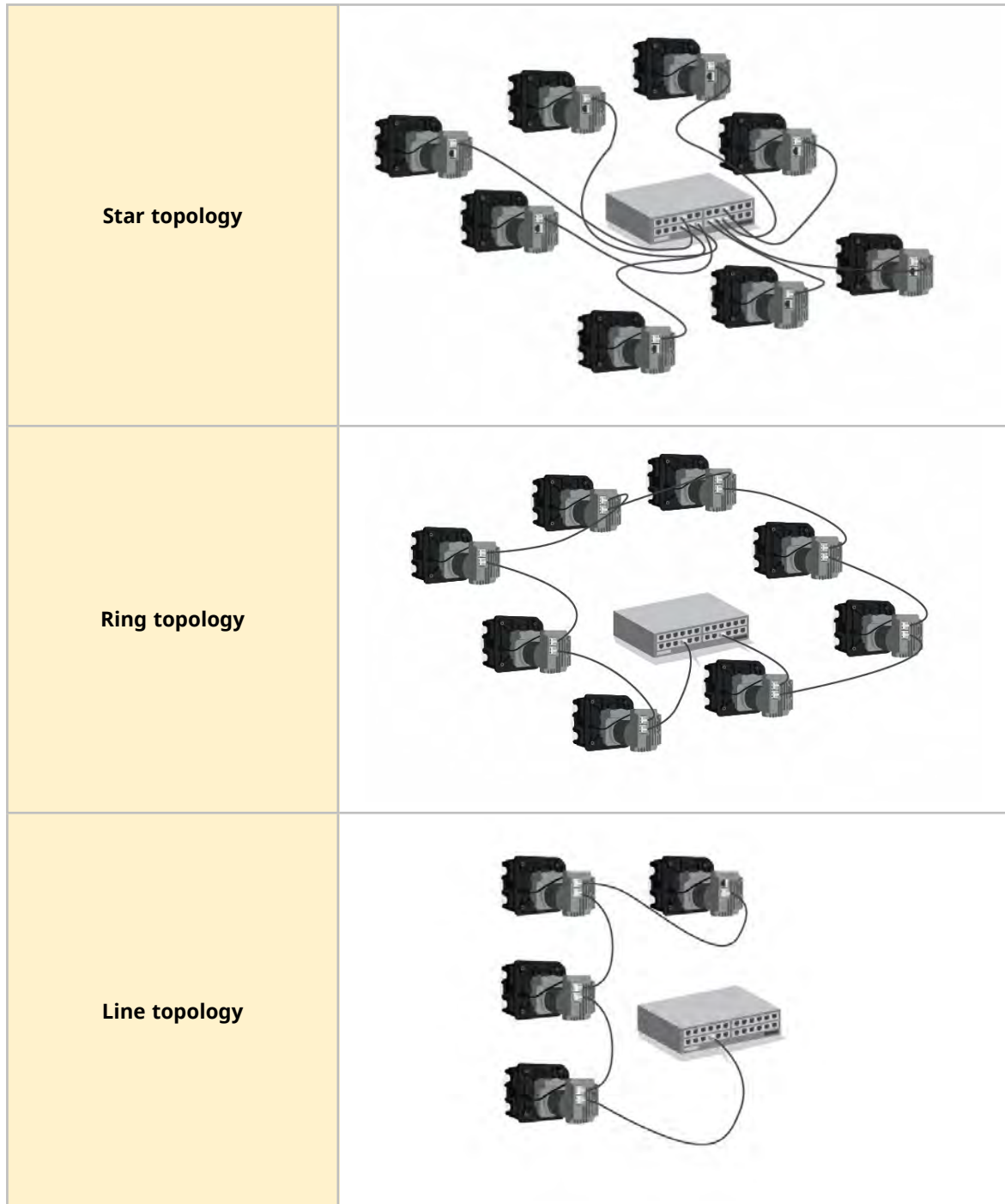

The number of pumps connected in the images above may be exceeded.

12.1.9 Use of DeciRPM

DeciRPM is used as a network speed parameter in place of rpm to avoid software complications with the decimal point.

1 Deci RPM = 0.1 RPM (For example: 1200 Deci RPM = 120 RPM)

12.1.10 Pumphead enumeration table and maximum design speed

The maximum design pump speed is provided in the table below.

If a speed limit is set higher than the maximum design speed the pump will not exceed its maximum design speed.

Output value	Pumphead	Max speed (Deci RPM)
1	114DV	4100
2	114DVP	4100
8	313D	4100
9	313D2	4100
12	314D	4100
13	314D2	4100
16	520R	2200
17	520R2	2200
19	520REL	2200
20	520REM	2200
26	RXMD 4 bar CW	5500
27	RXMD 4 bar CCW	5500
28	RXMD 6 bar CW	5500
29	RXMD 6 bar CCW	5500

12.1.11 Cyclic parameters

ADI	Name	Access	Type	Description
2	SetSpeed	Write	UInt16	Pump speed is set in Deci RPM. Max speed depends on model see, 'SetSpeedLimit'
3	SetSpeedLimit	Write	UInt16	Pump speed limit is set in Deci RPM. Max speed depends on model. See pumphead enumeration table: (See page 88)
4	SetFailsafeSpeed	Write	UInt16	If the failsafe is enabled the pump will run continuously at the specified speed in the event of a communications loss.
5	SetFailsafeEnable	Write	Bool	Set fail-safe enable. If set to 1 fail safe speed is enabled. Under loss of communication pump will run at fail safe speed. If set to 0 fail safe speed is disabled. Under loss of communication pump will stop
6	SetReverse	Write	Bool	Set pump direction to anti-clockwise, if set the pump will run anti-clockwise. Pump defaults to clockwise rotation
7	Run	Write	Bool	Start pump. If set to 1 pump will start subject to "Enable pump" parameter. If set to 0 pump will stop
8	RunEnable	Write	Bool	Enable pump. If set to 1 pump will start subject to "Start pump" parameter. if set to 0 pump will stop
9	ResetRunHours	Write	Bool	Reset pump run hours to zero. If set to 1 "Run hours" accumulator will be reset
12	ResetRevolutionCount	Write	Bool	Reset revolution count to zero. If set to 1, resets the Pump head revolution count to 0. Set to 0 to allow the Pumphead revolution count to increment.
14	RunHours	Read	UInt32	Reports the number of hours the pump has run
26	RevolutionCount	Read	UInt32	Reports the revolution count of the pumphead in full rotations
27	PumpSpeed	Read	UInt16	Reports the current pump speed based on encoder reading
28	SpeedLimit	Read	UInt16	Reports the current speed limit set point

ADI	Name	Access	Type	Description
29	GeneralAlarm	Read	UInt16	<p>Byte 1:</p> <p>Bit 0 = Motor Stall Error Bit 1 = Motor Speed error</p> <p>Bit 2 = Over Current Error Bit 3 = Over Voltage Error Bit 4 = Cover open Bit 5 = Unused Bit 6 = Unused Bit 7 = Unused</p> <p>Byte 2:</p> <p>Bit 0 = Under Voltage Error Bit 1 = Over Temperature</p> <p>Bit 2 = Software Fault Bit 3 = Hardware Fault</p> <p>Bit 4 = Voltage Range Error</p>
37	PumpModel	Read	Enum	Unused
38	PumpHead	Read	Enum	Displays the currently selected pump head. See PumpHead enumeration table - (See page 88)
43	Reverse	Read	Bool	Pump running anti clockwise. If set to 1, reports pump running anti clockwise
44	Running	Read	Bool	Pump is currently running. If set to 1, reports pump is currently running
46	MotorStallError	Read	Bool	Motor Stall error active. If set to 1, a Motor Stall Error has occurred
47	MotorSpeedError	Read	Bool	Motor Speed error. If set to 1, Motor Speed Error has occurred.
48	OverCurrentError	Read	Bool	Over current error active. If set to 1, Over current error has occurred.
49	OverVoltageError	Read	Bool	Over voltage error active. If set to 1, Over voltage error has occurred.
50	Integrated cover-open sensor	Read	Bool	Cover open. If set to 1, the pump will report that the pumphead cover has been opened.
61	AnybusNetworkMode	Read	Bool	If set the pump is in Ethernet IP Mode

ADI	Name	Access	Type	Description
62	AnybusNetworkActive	Read	Bool	If set Ethernet IP is active on the device
200	RPI Range	Read	SInt32	Reports the timings for cyclic data access
107	PumpTemperature	Read	Sint8	Reports the pump internal temperature
109	SoftwareFault	Read	Bool	SoftwareFault, if set to 1, Software fault has occurred
110	HardwareFault	Read	Bool	Hardware Fault, if set to 1, Hardware fault has occurred.
111	VoltageRangeError	Read	Bool	Voltage range error, if set PSU voltage is out of range
112	UnderVoltageError	Read	Bool	Under voltage error active. If set to 1, Under voltage error has occurred.
113	OverTemperatureError	Read	Bool	Over temperature error active. If set to 1, Over temperature error has occurred.
64	ErrorAcknowledge	Write	Bool	Acknowledge error. If set to 1 will acknowledge pump errors. Errors will only be cleared if the error condition no longer exists.
114	PrimeButtonActive	Read	Bool	Prime button is active, if set to 1, prime button is active

12.1.12 Acyclic data records

Index	Name	Access	Type	Description
108	SerialNumber	Read	Char21	Reports the pump serial number

12.1.13 Defaults

A DriveSure En pump is programmed with the following defaults. These defaults can be changed in the WM Connect PC software. ([See page 131](#)).

Item	Default setting
Acceleration (rpm/s)	900 rpm/s
Deceleration	1800 rpm/s

12.2 Part 2: Sub-Chapter installation procedures

12.2.1 Chapter pre-installation checklist

Prior to installing the control cable carry out the following pre-installation check. Make sure that:

- Pump has been installed in accordance with installation Chapter 1 and 2.
- All requirements of part 1 of this chapter have been met: ([See page 82](#))
- Power cable is not damaged
- Control cable is not damaged
- Integrated cover-open sensor cable is not damaged
- Pumphead cover is closed
- Fluid path to the pump has not yet been installed: ([See page 112](#))

If there is a problem with any of the pre-installation checklist items, do not proceed to the installation procedures in this chapter, until the matter is resolved.

12.2.2 Procedure: Connect the network control cable

1. Isolate the pump from its power supply
2. Push the network control cable(s) into the network control cable connection until a click is heard
3. Connect the power supply to the pump
4. Observe the status LEDs on the network control connections
5. Observe the status LEDs on the controller
6. Ensure the pump operates in accordance with the control system design (network commands).

13 Installation—Sub-Chapter 3C: Remote Control: DriveSurePn

This sub chapter details the remote control of a DriveSure Pn pump for PROFINET control.

13.1 Part 1: Sub-Chapter installation requirements, specification, and information

13.1.1 Specific responsible person

All PROFINET systems must be installed or certified by a PROFINET approved installation engineer.

13.1.2 Network parameters

The network parameters for communication of the pump with the network, are pre-programmed during production:

Parameter	Address
IP Address	0.0.0.0
Subnet mask	0.0.0.0
Default gateway	0.0.0.0
DCHP	Disabled

These network parameters can be manually configured or the DHCP enabled (automatic IP address), using either the network PC software or WM Connect PC software (See page 131).

13.1.3 GSDML File

The GSDML file may be downloaded from the Watson-Marlow website from the link below:

Web address: <https://www.wmfts.com/en/literature/other-resources/software-and-devices/>

13.1.4 Network control connection location

The location of the network control cable connection) is provided below:

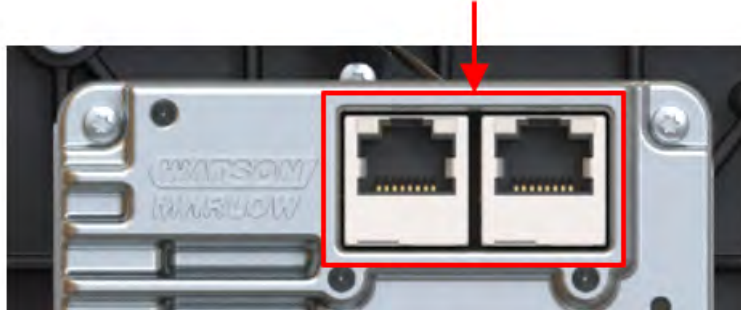

13.1.5 Network control cable specification

A category 5e. shielded cable PROFINET cable, with a male RJ45 connector is required to connect and control a DriveSure Pn drive.

13.1.6 Status LEDs (control cable connections)

The network control cable connections have LEDs which provide indication as detailed below.

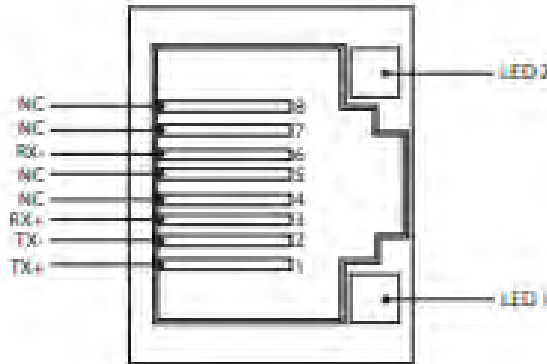

LED 1	LED 2	Indication
Low	Low	Off
Low	High	Yellow LED on for link detected, flickers to indicate 10 Mbit activity
High	Low	One green LED on for link detected, flickers to indicate 100 Mbit activity

13.1.7 Status LEDs (Integrated controller)

The controller has LEDs which provide an indication of status and errors.

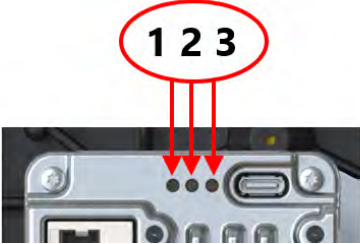
LED number	LED function	Picture showing LED number
LED 1	Module status	
LED 2	Network status	
LED 3	Drive status	

The behaviour of the LED lights is explained below

13.1.7.1 LED 1: Module Status

LED Colour	Description
No colour (off)	No power
Green	Controlled by a scanner in run state and, if CIP sync is enabled, time is synchronised to a grandmaster clock
Green, flashing	Not configured, scanner in idle state, or, if CIP sync is enabled, time is synchronised grandmaster clock
Red	Major fault (EXCEPTION-state, FATAL error, etc)
Red, flashing	Recoverable faults(s). Module is configured, but stored parameters differ from currently used parameters

13.1.7.2 LED 2: Network status

LED Colour	Description
No colour (off)	No power, or no IP address
Green	Online, one or more connections established (CIP class 1 or 3)
Green, flashing	Online, no connections established
Red	Duplicate IP address, FATAL error
Red, flashing	One or more connections timed out (CIP class 1 or 3)

13.1.7.3 LED 3: Drive status

Status LED colour	Description	
No colour (off)	No power	
Green	Pumphead cover closed, normal operation	
Amber	Pumphead cover open	
Red, flashing	Flashes	Error
	1	Over Voltage
	2	Under Voltage
	3	Over Current
	4	Software
	5	Stall
	6	Over Temperature Warning
	7	Over Temperature Shutdown
	8	Inverter Vds Overcurrent
	9	Inverter Sense Amplifier Overcurrent
	10	Inverter Undervoltage Lockout
	11	Inverter Gate Drive
	12	Inverter Charge Pump Undervoltage
	13	Voltage Range
14	Speed	

13.1.8 Network arrangement

A DriveSurePn pump may be connected in any of the following 3 network arrangements.

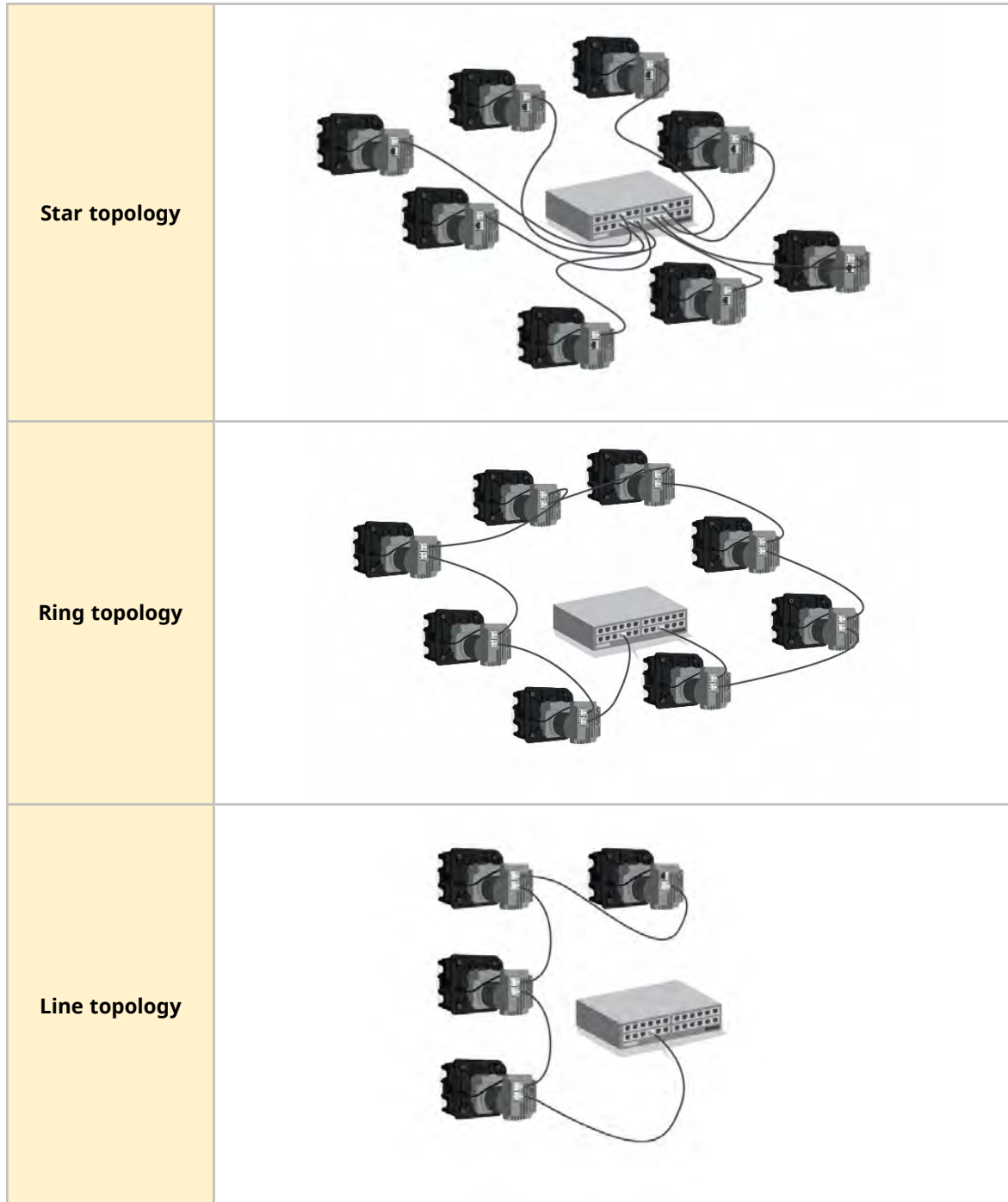

The number of pumps connected in the images above may be exceeded.

13.1.9 Use of DeciRPM

DeciRPM is used as a network speed parameter in place of rpm to avoid software complications with the decimal point.

1 Deci RPM = 0.1 RPM (For example: 1200 Deci RPM = 120 RPM)

13.1.10 Pumphead enumeration table and maximum design speed

The maximum design pump speed is provided in the table below.

If a speed limit is set higher than the maximum design speed the pump will not exceed its maximum design speed.

Output value	Pumphead	Max speed (Deci RPM)
1	114DV	4100
2	114DVP	4100
8	313D	4100
9	313D2	4100
12	314D	4100
13	314D2	4100
16	520R	2200
17	520R2	2200
19	520REL	2200
20	520REM	2200
26	RXMD 4 bar CW	5500
27	RXMD 4 bar CCW	5500
28	RXMD 6 bar CW	5500
29	RXMD 6 bar CCW	5500

13.1.11 PROFINETcycle time

Minimum device interval 32 ms.

13.1.12 Pump details and set up

ADI	Name	Access	Type	Description
38	Pump head	Read	UInt8	Displays the currently selected pump head. See pumphead enumeration table: (See page 100)
37	PumpModel	Read	UInt8 (Enum)	Unused

13.1.13 Pump status

ADI	Name	Access	Type	Description
14	Run hours	Read	UInt32	Reports the number of hours the pump has run
26	Total number pumphead revolutions	Read	UInt32	Reports the revolution count of the pumphead in full rotations
27	Current pump speed (decirPM)	Read	UInt16	Reports the current pump speed based on encoder reading (1 decirPM = 0.1 RPM)
28	Pump speed limit (decirPM)	Read	UInt16	Reports the current speed limit set point in decirPM (1 decirPM = 0.1 RPM). See pumphead enumeration table: (See page 100)
103	Pump status bitfield	Read	Byte	Bit 0 = Pump running anti clockwise. If set to 1, reports pump running anti clockwise Bit 1 = Pump is currently running. If set to 1, reports pump is currently running Bit 2 = Prime button is active, if set to 1, prime button is active
107	Pump temperature (deg C)	Read	SInt8	Reports the pump internal temperature

13.1.14 Pump control

ADI	Name	Access	Type	Description
2	Set pump speed (decirPM)	Write	UInt16	Pump speed is set in Deci RPM. Max speed depends on model, see 'set pump speed limit'
3	Set pump speed limit (decirPM)	Write	UInt16	Pump speed limit is set in Deci RPM. Max speed depends on model. See pumphead enumeration table: (See page 100)
4	Set failsafe speed (decirPM)	Write	UInt16	If the failsafe is enabled the pump will run continuously at the specified speed in the event of a communications loss.
101	Control bitfield	Write	UInt16	<p>Bit 0 = Set fail-safe enable.</p> <p>If set to 1 fail safe speed is enabled. Under loss of communication pump will run at fail safe speed.</p> <p>If set to 0 fail safe speed is disabled. Under loss of communication pump will stop</p> <p>Bit 1= Set pump direction to anti-clockwise, if set the pump will run anti-clockwise. Pump defaults to clockwise rotation</p> <p>Bit 2 = Start pump. If set to 1 pump will start subject to "Enable pump" parameter. If set to 0 pump will stop</p> <p>Bit 3 = Enable pump. If set to 1 pump will start subject to "Start pump" parameter. if set to 0 pump will stop</p> <p>Bit 4 = Reset pump run hours to zero. If set to 1 "Run hours" accumulator will be reset</p> <p>Bit 5 = Unused, Bit 6 =Unused</p> <p>Bit 7 = Reset revolution count to zero. If set to 1, resets the Pump head revolution count to 0. Set to 0 to allow the Pumphead revolution count to increment.</p>

13.1.15 Errors and warnings

ADI	Name	Access	Type	Description
102	Error bitfield byte 1	Read		<p>Bit 0 = Unused</p> <p>Bit 1 = Motor Stall error active. If set to 1, a Motor Stall Error has occurred.</p> <p>Bit 2 = Motor Speed error. If set to 1, Motor Speed Error has occurred</p> <p>Bit 3 = Over current error active. If set to 1, Over current error has occurred.</p> <p>Bit 4 = Over voltage error active. If set to 1, Over voltage error has occurred.</p> <p>Bit 5 = Cover open. If set to 1, the pump will report that the pumphead cover has been opened.</p> <p>Bit 6 = Unused</p> <p>Bit 7 = Unused</p>
	Error bitfield byte 2	Read		<p>Bit 0 = Unused</p> <p>Bit 1 (Bit9) = Under Voltage Error</p> <p>Bit 2 (Bit10) = Over Temperature Error</p> <p>Bit 3 (Bit11) = Software Fault, if set to 1, Software fault has occurred</p> <p>Bit 4 (Bit12) = Hardware Fault, if set to 1, Hardware fault has occurred.</p> <p>Bit 5 (Bit13) = Voltage range error, if set PSU voltage is out of range</p>
64	Acknowledge error	Write	UInt8	<p>Bit 0 = Acknowledge error. If set to 1 will acknowledge pump errors. Errors will only be cleared if the error condition no longer exists.</p>

13.1.16 Acyclic parameters

ADI	Name	Access	Type	Description
108	Pump serial number	Read	Char21	Read the pump serial number

13.1.17 Defaults

A DriveSure Pn pump is programmed with the following defaults. These defaults can be changed in the WM Connect PC software. (See [page 131](#)).

Item	Default setting
Acceleration (rpm/s)	900 rpm/s
Deceleration	1800 rpm/s

13.2 Part 2: Sub-Chapter installation procedures

13.2.1 Sub-Chapter pre-installation checklist

Prior to installing the control cable carry out the following pre-installation check. Make sure that:

- Pump has been installed in accordance with installation chapter 1 and 2.
- Requirements of part 1 of this chapter have been met:
- Power cable is not damaged.
- Control cable is not damaged.
- Integrated cover-open sensor cable is not damaged.
- Pumphead cover is closed.
- Fluid path to the pump has not yet been installed: ([See page 112](#))

If there is a problem with any of the pre-installation checklist items, do not proceed to the installation procedures in this chapter, until the matter is resolved.

13.2.2 Procedure: Connect the network control cable

1. Isolate the pump from its power supply.
2. Push the network control cable(s) into the network control cable connection until a click is heard.
3. Connect the power supply to the pump.
4. Observe the status LEDs on the control cable connections.
5. Observe the status LEDs on the controller.
6. Ensure the pump operates in accordance with the control system design (network commands).

14 Installation—Chapter 4: Local control

The information in this chapter covers the following

- Integrated cover-open sensor
- Prime switch connection

14.1 Part 1: Chapter installation requirements, specification, and information

14.1.1 Integrated cover-open sensor

The integrated cover-open sensor will stop the pump, if the pumphead cover is opened during operation.

The cable is connected to the controller as illustrated below:

Item number	Name	Picture showing items
1	Integrated cover-open sensor cable (pumphead to controller)	
2	Integrated cover-open sensor cable connection	

14.1.1.1 Connection

The integrated cover-open sensor cable connection is a restricted connection by Watson-Marlow. For this reason, no connection specification or wiring information is provided.

This connection must not be tampered with.

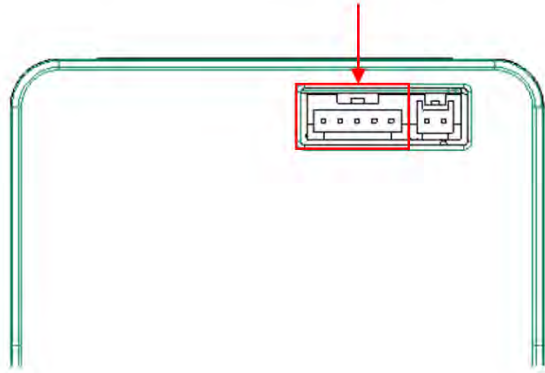
Item	Specification
Connector location	

14.1.2 Prime switch connection

A prime switch connection is provided to allow the pump to run at a set speed while a switch is activated, such as for priming of the pump.

14.1.2.1 Connection and cable specification

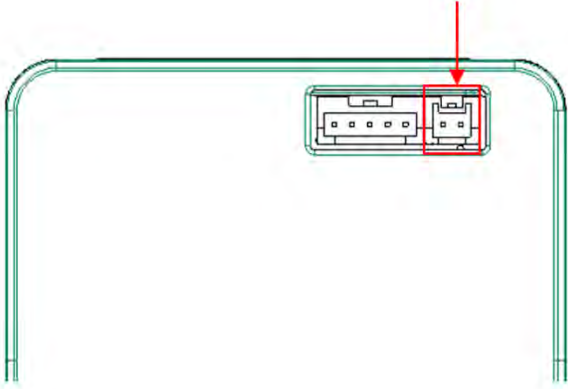
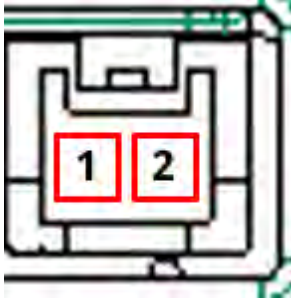
Item	Specification
Connection on controller	JST 2W B02B-PASK-1
Connection required on cable ¹	JST 2W PAP-02V-S housing with SPHD-002T-P0.5 Crimp
Connector Location	
Connector pin outs	
Wiring information	<p>A voltage free switch connection must be made between pin 1 and 2 to activate the prime feature.</p> <p>Do not connect any external voltage to either pin (1 or 2).</p>

NOTE 1

A prime switch cable with required connector is not available as a Watson-Marlow accessory

14.2 Part 2: Chapter installation procedures

Prior to the installation of local control carry out the following pre-installation check. Make sure that:

- Pump has been installed in accordance with installation chapter 1, 2 and 3.
- All requirements of part 1 of this chapter have been met:
- Power cable is not damaged.
- Control cable is not damaged.
- Integrated cover-open sensor cable is not damaged.
- Pumphead cover is closed.
- Prime switch electrical system is installed if this connection will be used.
- Fluid path to the pump has not yet been installed: ([See page 112](#))

If there is a problem with any of the pre-installation checklist items, do not proceed to the installation procedures in this chapter, until the matter is resolved.

14.2.1 Installation of the integrated cover-open sensor

The integrated cover open sensor cable is pre-installed during production of the 300 Series, 400 Series and 500 Series series pumps.



For the 100 Series pumps, this cable connection is installed during mounting procedure (See page 67)

14.2.1.1 Testing the integrated cover-open sensor

During the installation sequence, the operation of the integrated cover-open sensor must be tested. This is undertaken as follows:

With the pump powered up and operating:

1. Open the cover in accordance with the table below

100 Series, 300 Series and 400 Series	500 Series
<p>Lift the cover</p>  	<p>Unlock the pumphead cover by turning the cover fastener ¼ turn anticlockwise with a flat-head screwdriver.</p> 

2. The pump should immediately stop. The status LED nearest the USB-C port will illuminate and for En, and Pn drives, a pump status update will be sent over the network

If these actions do not happen, the integrated cover-open sensor is not functioning correctly, and the installation must not continue until the fault is rectified.

14.2.2 Prime switch connection

14.2.2.1 Set up

The prime speed can be set up using WM Connect PC software. Network software may also be used for Pn and En models using the network parameters.

14.2.2.2 Procedure: Connect the prime switch

If a prime switch connection will be used, carry out the following procedure to connect to the pump:

1. Isolate the pump from its power supply.
2. Push the prime switch connection into the prime switch connector on the controller until a secure connection is made.
3. Connect the power supply to the pump.
4. Ensure the pump operates in accordance with the prime switch activation and deactivation method.

15 Installation—Chapter 5: Fluid path

15.1 Part 1: Chapter installation requirements, specification, and information

A Watson-Marlow pump should be installed into a fluid path system with specific ancillary devices to ensure safe operation. These requirements are detailed in the sections below.

All devices, connections or pipework must be:

- Chemically compatible with the pumped fluid
- Have a specification rating higher than that of the application.

15.1.1 Overpressure safety device

A Watson-Marlow pump operates by positive displacement. Should a blockage or restriction occur, the pump will continue to operate until either of the following occur:

- The pumphead tubing or element, or ancillary device may rupture, leak or otherwise fail
- The fluid path pipework or ancillary device, may rupture, leak or otherwise fail
- The drive fails

Install an overpressure safety device which can automatically activate in an overpressure event. This device should:

- Be able to be set to a pressure which is lower than the pressure rating of the system
- Be able to stop the pump or divert the fluid to a safe location upon being triggered
- Have a failsafe feature

15.1.2 Non-return valve

Install a non-return valve in the discharge fluid path as close as possible to the pumphead in applications where pressurised backflow could create a hazard in the event of a pumphead tube or element failure. If the pump is to be operated in reverse, the non-return valve will need to be bypassed during this operation, to avoid becoming a blockage.

15.1.3 Isolation and drain valves

Isolation and drain valves must be installed in the fluid path in the following scenarios:

- Where it is not practical to drain the entire fluid path during:
 - Pumphead tubing or element replacement
 - Where procedures require the pump to be removed from service, such as due to a fault
- The pump will act like a valve when stopped, preventing fluid from flowing through the pumphead.
 - However, as the tubing, element, or pumphead wears, there can be flow through the pumphead. In applications where unintentional flow through the pumphead, cannot be tolerated or would create a hazard, then isolation valves must be installed.

Valves must be opened before the pump operates and closed after the pump has stopped.

15.1.4 Inlet and discharge pipework

Inlet and discharge pipes should be should:

- be as short as possible
- be as direct as possible
- follow the straightest route
- Use bends of large radius
- With the largest diameter bore tube that will fit with your process

15.1.5 Piping vibration

Peristaltic pumps produce a pulsation which results in vibration of the peristaltic tubing and fluid path.

A Piping vibration and integrity assessment should be undertaken to determine the level of vibration suitable for the installation.

15.2 Part 2: Chapter installation procedures

15.2.1 Chapter pre-installation checklist

Prior to installing the fluid path carry out the following pre-installation check to make sure that:

- Pump has been installed in accordance with installation chapter 1, 2, 3, and 4.
- All requirements of part 1 of this chapter have been met:
- Power cable is not damaged.
- Control cable is not damaged.
- Integrated cover-open sensor cable is not damaged.
- Pumphead cover is closed.

If there is a problem with any of the pre-installation checklist items, do not proceed to the installation procedures in this chapter, until the matter is resolved.

15.2.2 Procedure: Installation of the peristaltic tubing into the pumphead for the first time

The first-time installation of the peristaltic tubing or element varies by model of pumphead. Some pumphead models require adjustment of the tube clamps prior to installation of the tubing. The table below explains which models this applies to

Pumphead	Requires tube clamp adjustment?
114DV	Yes
114DVP	Yes
313D ¹	Yes ¹
313D2 ¹	Yes ¹
314D ¹	Yes ¹
314D2 ¹	Yes ¹
RXMD	No
520R	Yes
520R2	Yes
520REL	No
520REM	No

NOTE 1

Some models of 313D, 313D2, 314D and 314D2 have fixed tube clamps. These models do not require tube clamp adjustment prior to installation of the tube.



Follow the procedures in this section to install peristaltic tubing in the pumphead for the first time. If the peristaltic tubing needs to be replaced for maintenance reasons, follow the replacement peristaltic tubing procedure: ([See page 140](#))

15.2.2.1 100 Series pumphead tube clamp settings

Prior to installation of tubing, the tubing clamp setting must be correctly set. The tube clamps holder is factory set to Outer Position (Large bore).

The tubing clamps can be adjusted to accommodate 1.6 mm wall tubing in sizes from 0.5 mm bore to 4.8 mm bore.

Tube Bore	0.5 mm	0.8 mm	1.6 mm	2.4 mm	3.2 mm	4.0 mm	4.8 mm
Inner	●	●	●	●	●		
Outer				●	●	●	●

Position	Picture	Comment
Inner Position (Small bore)		The inner position is used to prevent the risk of tube slipping through the clamps and wandering across the rollers when using 0.5 mm, 0.8 mm and 1.6 mm bore tubes.
Outer Position (Large bore)		The outer position is used to prevent flow rate being excessively reduced when using 4.0 mm and 4.8 mm bore tubing.

Tubing bores of 2.4 mm and 3.2 mm can use either setting.

The inner setting clamps the tube harder, reducing slip but marginally reduce flow rate. The outer setting will optimise flow rate but will increase risk of slip.

15.2.2.1.1 Change from large to small tube setting

1. Isolate from power supply.
2. Use a pointed device like a pall-point pen to reposition the lower tube holders on both sides.
3. Fully open flip top cover.
4. Place pointed device down into the small depression as shown in first picture.



5. Press down and slightly away from the front of the pumphead, as shown above.
6. Maintain the angled downward pressure and push away from the front of the pumphead so the lower tube holder moves towards the back of the pumphead into its new position.
7. Release pressure, and check that the jaw rises into its correct alignment as shown below.

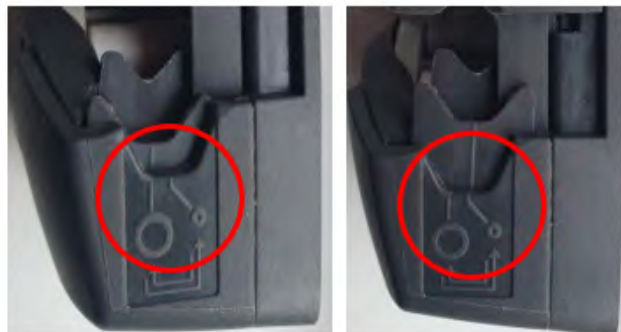

8. If it does not, repeat the procedure, being sure to maintain downward pressure until release.
9. Adjust the tube holder on the other side of pumphead in the same way.

15.2.2.1.2 Change from small to large tube setting

1. Isolate from power supply.
2. Use a pointed device like a ball-point pen to reposition the lower tube holders on both sides.
3. Fully open flip top cover.
4. Place pointed device down into the small depression as shown in first picture.



5. Press down and slightly away from the back of the pumphead as shown above.
6. Maintain the angled downward pressure and push away from the back of the pumphead as the lower tube holder moves towards the front of the pumphead into its new position.
7. Release pressure, and check that the jaw rises into its correct alignment as shown below.



8. If it does not, repeat the procedure, being sure to maintain downward pressure until release.
9. Adjust the tube holder on the other side of pumphead in the same way.

15.2.2.2 100 Series pumphead first time tube installation

1. Isolate pump from electrical power supply.
2. Fully open the flip top cover.



3. Ensure the tube clamps are correctly set for size of tube.
4. Place tube between rotor rollers and track and press against inner wall.
5. Check that tube is not twisted or stretched and is inside the tube clamps.

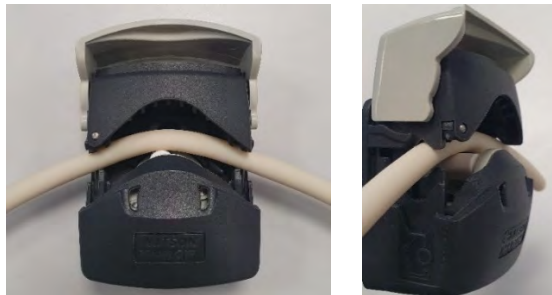

6. Lower flip top cover to fully closed position, this will automatically tension the tube correctly.
7. Check that tubing is in the position shown. Do not add extra tension to the tube.



8. Connect the peristaltic tubing to the fluid path in accordance with your organisation's procedure.
9. Bring the pump into service, checking for any leaks from fluid path connections.
10. If using Marprene or Bioprene, retention the tubing after the first 30 minutes of operation, as the tube may grow in length during this bedding in time. Repeat all previous steps in this procedure to re-tension the tube.

15.2.2.3 300 Series pumphead tube clamp setting

300 Series pumpheads with adjustable tube clamps require setting prior to installation of the tubing. For the fixed clamp versions this is not necessary.

The tube clamps are located on each side of the pumphead. The location and description of the individual items is provided below:

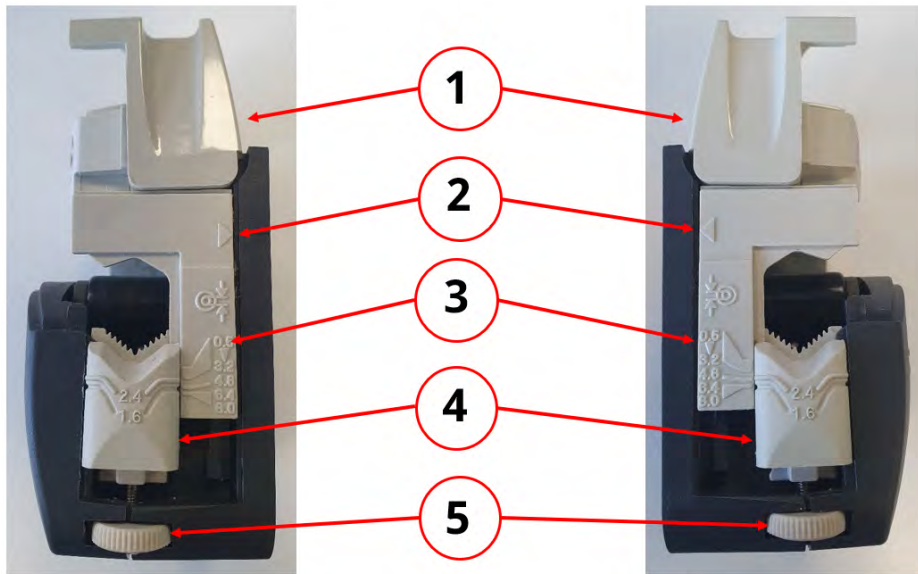

Item	Description
1	Flip top cover
2	Slider arrow
3	Tube bore indicator
4	Tube wall thickness indicator
5	Tube clamp adjustment wheel

The tubing clamps can be adjusted to accommodate 1.6 mm and 2.4 mm tubing wall thickness, and tubing bore sizes from 0.5 mm to 8.0 mm.

15.2.2.3.1 To set or adjust the tube clamp.

1. Isolate pump from electrical power supply.
2. Fully open the flip top cover.



3. Ensure that the arrow on slider aligns with the line on body.



4. Rotate adjusting wheel on the clamp assembly so that the required tube wall thickness aligns with the required tube bore size. Adjusting wheel operates clockwise to lower and anti-clockwise to raise.

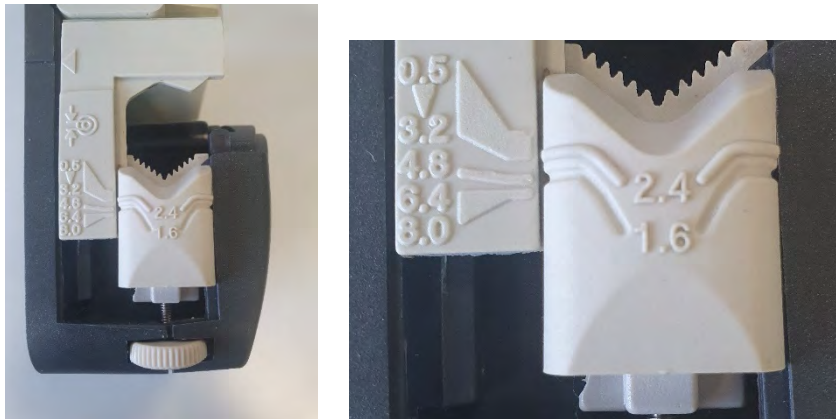

(Adjustment for 1.6 mm wall thickness and 4.8 mm tube bore size shown).

5. Carry out step 4 on opposite side clamp.
- 6.

15.2.2.4 300 Series pumphead first time tube installation

1. Isolate the pump from the electrical power supply.
2. Fully open the flip top cover.



3. Ensure that tube clamps are correctly set for size of tube.
4. Place tube between rotor rollers and track (ensure it is pressed against inner wall).
5. Check that tube is not twisted or stretched and is inside the tube clamps.



6. Lower flip top cover to fully closed position, this will automatically tension the tube correctly.
7. Check that tubing is in the position shown. Do not add extra tension to the tube.



8. Connect the peristaltic tubing to the fluid path in accordance with your organisation's procedure.
9. Bring the pump into service, checking for any leaks from fluid path connections.
10. If using Marprene or Bioprene, retention the tubing after the first 30 minutes of operation, as the tube may grow in length during this bedding in time. Repeat all previous steps in this procedure to re-tension the tube.

15.2.2.5 400 Series pumphead tube clamp setting

RXMD pumpheads do not have adjustable tube clamps. Proceed to the first-time tube installation procedure. ([See page 126](#)).

15.2.2.6 400 Series pumphead first time tube installation

1. Isolate pump from electrical power supply.
2. Fully open the flip top cover.



3. Ensure the correct tubing size for the tube clamps for the tube clamps will be installed.
4. Place tube between rotor rollers and track, ensuring that tubing is seated closing the cover
5. Check that tube is not twisted or stretched and is inside the tube clamps.



6. Lower flip top cover to fully closed position, this will automatically tension the tube correctly.
7. Check that tubing is in the position shown. Do not add extra tension to the tube.



8. Connect the peristaltic tubing to the fluid path in accordance with your organisation's procedure.
9. Bring the pump into service, checking for any leaks from fluid path connections.

15.2.2.7 500 Series tube clamp adjustments R and R2

The pumpheads are fitted with spring-loaded tube clamps which must grip the tubing tightly enough to stop it moving in and out of the pumphead but must not over-squeeze the tube and throttle fluid flow. The tubing clamps are fitted with yellow sliders which can be clicked into two positions while the clamps are held open.

The outer position allows the clamps to grip the tube tightly, and the inner will grip the tube loosely. Adjust the sliders to prevent tube movement during a few trial rotations of the rotor.

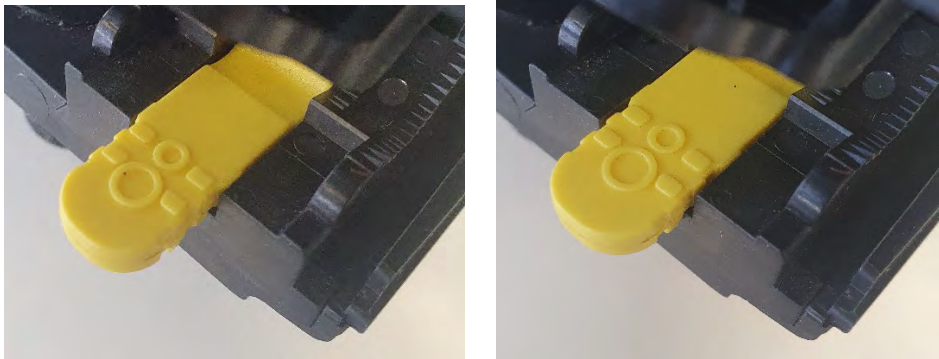

Outer position Inner position

Final tube clamp setting will be made during the tubing installation procedure.

15.2.2.8 500 Series tube installation R and R2

1. Isolate the pump from the electrical power supply.
2. Unlock the pumphead cover by turning the cover fastener $\frac{1}{4}$ turn anticlockwise with a flat-head screwdriver.



3. Open the cover to its full extent to create maximum clearance for the tube ports.



4. Mark a 225 mm length onto the section of the tubing which is to be located into the pumphead.



5. Open the lower spring-loaded tube clamp and locate tubing, with the first 225mm length mark aligned to the inside face of the spring-loaded part of the tube clamp. Release the clamp.



6. Disengage the rotor clutch by fully depressing the yellow clutch button on the side of the rotor hub and turning the hub a few degrees while the clutch button is still depressed. The rotor can now rotate independently of the gearbox and motor for one full revolution. If the clutch re-engages before tube fitting is complete, depress the clutch button again and turn the rotor a few degrees.



7. Feed the tubing around the pumphead track, turning the rotor as necessary. Make sure the tubing is not twisted.



8. Ensure that the second 225 mm mark is adjacent to the inner edge of the upper tube clamp. Open the upper spring-loaded tube clamp and locate the tubing into it, making sure there is no residual twist in the tubing, and that the tube sits centrally between the tube guide rollers. Release the clamp.



9. Check the spring-loaded tube clamps grip the tubing tightly enough to stop it moving in and out of the pumphead but must not over-squeeze the tube. Adjust the sliders to prevent tube movement during a few trial rotations of the rotor. The outer position will allow the clamps to grip the tube tightly, and the inner will grip the tube loosely
10. Close the cover, pushing it fully home until the latch engages.



11. Connect the peristaltic tubing to the fluid path in accordance with your organisation's procedure.
12. Bring the pump back into service, checking for any leaks from fluid path connections.
13. If using Marprene or Bioprene, retention the tubing after the first 30 minutes of operation, as the tube may grow in length during this bedding in time. Repeat all previous steps in this procedure to re-tension the tube.

15.2.2.9 500 Series tube element installation REL and REM

Tubing elements do not require tube clamp adjustment prior to the installation of the element.

1. Isolate the pump from electrical power.
2. Unlock the pumphead cover by turning the cover fastener $\frac{1}{4}$ turn anticlockwise with a flat-head screwdriver.



3. Open the cover to its full extent to create maximum clearance for the tube ports.
4. Place one connector end of the element into the lower housing.



5. Disengage the rotor clutch by fully depressing the yellow clutch button on the side of the rotor hub and turning the hub a few degrees while the clutch button is still depressed. The rotor can now rotate independently of the gearbox and motor for one full revolution. If the clutch re-engages before tube fitting is complete, depress the clutch button again and turn the rotor a few degrees.

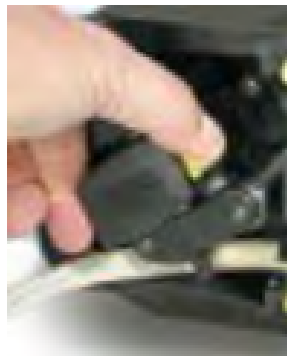

6. Feed the tubing element around the pumphead track, turning the rotor, as necessary.



7. Place the opposite connector end of the element into the top housing. Making sure the element is not twisted and sits centrally between the rollers.



8. Close the cover, pushing it fully home until the latch engages.



9. Connect the peristaltic tubing to the fluid path in accordance with your organisation's procedure.
10. Bring the pump back into service, checking for any leaks from fluid path connections.

16 WM Connect PC software

The WM Connect PC software may be used for:

- Configuring pump control and performance settings
- Changing defaults
- Manual override for testing performance and simulating faults
- Viewing pump status information
- Load / save pump configurations
- Performing pump firmware updates
- Viewing pump log

16.1 Part 1: Requirements, specification, and information

16.1.1 Operating system requirements

WM Connect PC software requires a computer using windows 10 and above.

16.1.2 WM Connect download

WM Connect PC software can be downloaded from the Watson-Marlow website using the link below:

Web address: <https://www.wmfts.com/en/literature/other-resources/software-and-devices/>

16.2 Part 2: Procedures

16.2.1 Pre-procedure checklist

Prior to use of WM Connect PC software carry out the following check to ensure:

- The pump has been installed in accordance with installation Chapter 1 and 2.
- All requirements of part 1 of this section have been met:
- The power cable is not damaged.
- The integrated cover-open sensor cable is not damaged.
- The pumphead cover is closed.
- A USB-C (2.0) cable of a suitable length for the installation is to hand.
- The WM Connect software has been downloaded and installed on a computer

If there is a problem with any of the checklist items, do not proceed until the matter is resolved.

16.2.2 Procedure: Connect to WM Connect

Connect the pump to WM Connect using the following procedure

1. Complete the pre-installation checklist provided: ([See page 132](#))
2. Open WM Connect PC software on the computer. You should see an animated version of the image below as the software looks for a pump.



3. Connect a USB-C (2.0) cable between the pump and the computer using the USB-C connection illustrated below:



4. Connect the pump to the power supply.

The software and the pump will now connect, and the following homepage will be displayed

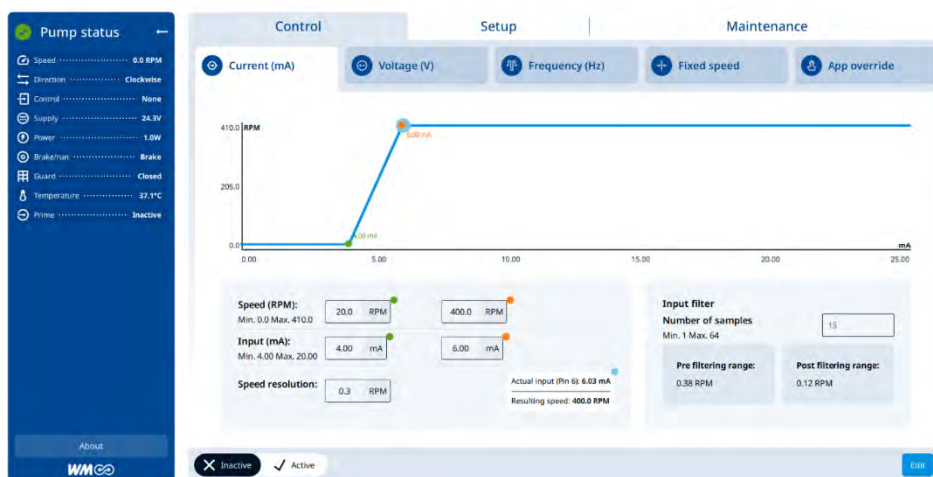

16.2.3 Using WM Connect for optimisation

WM Connect can be used for optimisation. Contact your local Watson-Marlow representative for more information.

16.2.4 Using WM Connect for troubleshooting

WM Connect will provide an indication of the type of fault which is communicated by the network or indicated by ADC. Contact your local Watson-Marlow representative for more information.

16.2.5 Using WM Connect for other tasks

16.2.5.1 Pump control

Do not use WM Connect, as the method of pump control. WM Connect must only be used for configuration, optimisation, or troubleshooting.

16.2.5.2 Programming of pumphead

During manufacture, the installed pumphead model is programmed into the drive software, to ensure the pumphead cannot exceed its maximum design speed.

WM Connect must be used to carry out this programming, in the following scenarios:

- Drive only supply
- Change of pumphead model from the model originally installed at time of manufacture.

Contact your local Watson-Marlow representative for more information on programming. In any other scenario, the programmed pumphead, must not be changed using WM Connect.

CAUTION



Operating the pump with the incorrect pumphead programmed in the configuration settings can result in the pumphead speed exceeding its maximum design speed. This can result in pumphead failure, drive failure or other hazards because of excessive speed. To avoid these potential hazards, ensure the pumphead model matches the programmed pumphead.

17 Operation

This section provides guidance to assist a responsible person with the preparation of operator instructions.

A responsible person must produce final safety information¹ and instructions (installation, operation, and maintenance), for the final end user and operator of the piece of equipment into which a DriveSure pump will be integrated.

An operator must not use these instructions for reference of the product.

NOTE 1

The form and format of the final safety information and instructions are dependent upon the final design, residual risks, and certification requirements of the piece of equipment into which a DriveSure pump will be integrated.

17.1 Pre-operation checklist

A pre-operation checklist should consider the following points. Make sure that:

- Pump has been installed by a responsible person for each of the installation chapters.
- A responsible person can confirm:
 - Power cable is not damaged
 - Control cable(s) is not damaged
 - Integrated cover-open sensor cable is not damaged
 - Integrated cover-open sensor system has been tested
- Pumphead cover is closed
- Leaks of fluid from any connection with the pump stationary

If there is a problem with any of the pre-installation checklist items, do not proceed to operate the pump, and instruct that the pump is removed from service by a responsible person, until the matter is resolved.

17.2 Safety

17.2.1 Hazards that may occur during operation

The following hazards may occur during operation of the pump.

17.2.1.1 Rotating parts

CAUTION



Do not open the pumphead cover to stop a pump which is rotating. The pump must be stopped or started using the control system. In an emergency—stop the pump using the electrical power isolation switch.

17.2.1.2 Unexpected operation

CAUTION



Pump models which are controlled by a control system, may operate unexpectedly in response to the control system. Obtain training from a responsible person on the expected operation of the pump by the control system prior to operation of the pump.

17.2.1.3 Risk of burns

CAUTION



Risk of injury due to burns. The exterior of the pump can get hot during operation. Stop the pump and let the pump cool before handling.

17.2.1.4 Dry running

The pump can be run dry for short time periods, such as during priming (air bubbles) or when there is fluid with pockets of gas.

NOTICE

Risk of damage to the pump or pumphead. The pumphead is not designed to be run dry for extended periods of time. Dry running will generate excessive heat. Do not run the pump dry for extended periods.

18 Cleaning

18.1 Overview

Watson-Marlow confirm that fresh water is compatible with all exposed pump surfaces. No other cleaning agents or chemicals are approved for use.

A responsible person must:

- Carry out a risk assessment to approve fresh water as a suitable cleaning agent. Consider potential compatibility with:
 - process chemicals
 - residue or other material deposits on pump surfaces and installation area.
- Create a specific procedure for the application, using the general procedure provided below as guidance.

18.2 General procedure for guidance

1. Stop the pump
2. Isolate from power supply
3. Clean the pump by wiping all exposed surfaces with a dry cloth or cloth dampened with water (as approved). Repeat until all residue has been removed.
4. Allow any remaining water to evaporate from surfaces
5. Reconnect the power supply
6. Bring pump back into operation

If pump is not operating as intended after cleaning:

1. Stop the pump
2. Isolate power supply
3. Instruct a responsible person to remove pump from service.

19 Maintenance

19.1 Spare parts and accessories

A DriveSure pump is available with the following Watson-Marlow spare parts and accessories.

19.1.1 Drive

Type	Product name	Product code
Power cable ¹	1 m (3.28 Ft) 12 to 48 V DC power cable	009.1PW.DVS
	3 m (9.84 Ft) 12 to 48 V DC power cable	009.3PW.DVS
Cable pack ²	DriveSure cable pack - 24V power supply/USB-C - trials only	009.24CP.DVS
	DriveSure cable pack - 48V power supply/USB-C - trials only	009.48CP.DVS
Control cable ³	DriveSure En ADC 1m (3.28 ft) control cable	009.1CC.DVS
	DriveSure En ADC 3m (9.84 ft) control cable	009.3CC.DVS
	Ethernet Cable, RJ45 to RJ45, CAT 5e SHIELDED, 3m (9.84 Ft)	059.9123.000
	PROFINET Cable, RJ45 to RJ45, CAT 5e SHIELDED, 3m (9.84 Ft)	059.9128.000

- NOTE 1** The power cables are only suitable for connection to the integrated controller.
- NOTE 2** The cable pack is for trial use only. It includes an AC to DC power adapter, and USB-C cable. The power adapter in the cable pack does not include a power cable for the AC adapter power connection.
- NOTE 3** DriveSureADC pump is supplied with a control cable, which is available as a spare part. A DriveSureEn, or Pn pumps is not supplied with a control cable, these cables may only be purchased as an accessory.

19.1.2 Pumphead

Type	Product name	Product code
Pumphead mounting plate	100 Series pumphead mounting plate	019.IPMP.DVS
	300 Series pumphead mounting plate	039.IPMP.DVS
	400 Series pumphead mounting plate ¹	Not applicable
	500 Series pumphead mounting plate	059.IPMP.DVS
Tubing	Contact your local Watson-Marlow representative for product code	
Fluid connectors	Contact your local Watson-Marlow representative for product code	

NOTE 1

400 Series pumpheads mounting plates are not replaceable by a user. If a new mounting plate is required, remove the pump from service and contact your Watson-Marlow representative to discuss the replacement of the mounting plate by Watson-Marlow.

19.2 Electrical maintenance

19.2.1 Drive maintenance

There are no replaceable or serviceable parts within the drive (motor, gearbox, and controller). If the pump drive is damaged remove the pump from service and contact your Watson-Marlow representative to discuss how the pump can be repaired or replaced.

Do not attempt to repair or replace any part of the drive.

19.2.2 Replacement of power cable

The power cable is detachable. If the power cable or power cable connection becomes damaged, remove the pump from service and contact your Watson-Marlow representative to order a new power cable.

Do not replace the power cable, with a non-Watson-Marlow power cable. This requirement is to protect against either inadequately rated cables, or incorrect polarity.

19.2.3 Replacement of fuses

A DriveSure pump does not contain any replaceable fuses within the product. Overcurrent protection such as an external replaceable fuse in the electrical power supply circuit, is a requirement of the electrical installation. See (See page 71).

19.3 Pumphead maintenance

19.3.1 Life of peristaltic tubing

The peristaltic tubing used in the pumphead is a key consumable item. It is not possible for Watson-Marlow to predict the precise life of the tubing due to multiple factors such as speed, chemical compatibility, and pressure amongst other factors.

Either of the following are an indication that the tubing is near its end of life:

- The flowrate drops from its normal rate of flow, which is otherwise unexplained (i.e. not due to a change in fluid viscosity, or inlet pressure, discharge pressure, etc)
- The pumphead begins to allow fluid to leak past the tubing roller pinch points when the pump is stopped.

These indications can be used to monitor the life of a tubing so that it may be changed prior to failure.

19.3.2 Replacing the peristaltic tubing in the pumphead

Follow these procedures to replace the tubing or element with the same size and material tubing which has been used. If a different size or material is used, it will be necessary to re-adjust the tube clamps, and the procedure for installing the tubing for the first time should be used instead. See [\(See page 112\)](#).

19.3.2.1 100 Series: Replacing the peristaltic tubing

1. Stop the pump.
2. Isolate the pump from electrical power.
3. Drain down and disconnect the fluid path in accordance with your organisation's procedure.
4. Fully open the flip top cover.



5. Ensure that tube clamps are correctly set for size of tube.
6. Place tube between rotor rollers and track and press against inner wall.
7. Check that tube is not twisted or stretched and is inside the tube clamps.



8. Lower flip top to fully closed position, this will automatically tension the tube correctly.
9. Check that tubing is in the position shown. Do not add extra tension to the tube

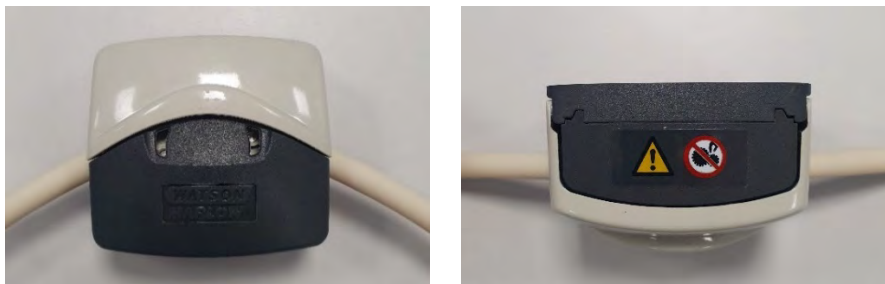

10. If using Marprene or Bioprene, retention the tubing after the first 30 minutes of operation, as the tube may grow in length during this bedding in time. Repeat all previous steps in this procedure to re-tension the tube.

19.3.2.2 300 Series: Replacing the peristaltic tubing

1. Stop the pump.
2. Isolate the pump from electrical power.
3. Drain down and disconnect the fluid path in accordance with your organisation's procedure.
4. Fully open the flip top cover.



5. Ensure that tube clamps are correctly set for size of tube.
6. Place tube between rotor rollers and track and press against inner wall.
7. Check that tube is not twisted or stretched and is inside the tube clamps.



8. Lower flip top cover to fully closed position, this will automatically tension the tube correctly. Check that tubing is in the position shown. Do not add extra tension to the tube.

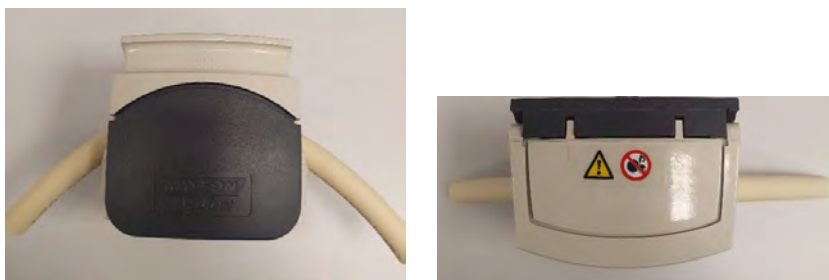

10. If using Marprene or Bioprene, retention the tubing after the first 30 minutes of operation, as the tube may grow in length during this bedding in time. Repeat all previous steps in this procedure to re-tension the tube.

19.3.2.3 400 Series: Replacing the peristaltic tubing

1. Stop the pump
2. Isolate pump from electrical power supply.
3. Drain down and disconnect fluid path in accordance with your organisation's procedure.
4. Fully open flip top cover.

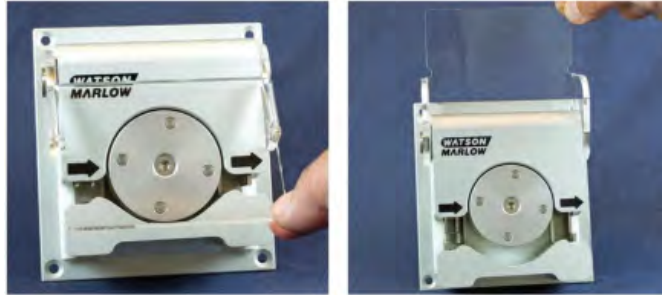

5. Ensure the correct tubing size for the tube clamps will be installed.
6. Place tube between rotor rollers and track, ensuring that tubing is seated before closing cover.
7. Check that tube is not twisted or stretched and is inside the tube clamps.



8. Lower flip top cover to fully closed position, this will automatically tension the tube correctly.

9. Check that tubing is in the position shown. Do not add extra tension to the tube.



10. Connect the peristaltic tubing to the fluid path in accordance with your organisation's procedure.
11. Bring the pump into service, checking for any leaks from fluid path connections

19.3.2.4 500 Series tube replacement (R and R2)

1. Stop the pump.
2. Isolate the pump from electrical power.
3. Drain down the fluid path in accordance with your organisation's procedure.
4. Disconnect the peristaltic tubing from the fluid path, in accordance with your organisation's procedure.
5. Unlock the pumphead cover by turning the cover fastener $\frac{1}{4}$ turn anticlockwise with a flat-head screwdriver.



6. Open the cover to its full extent to create maximum clearance for the tube ports.



7. Unclip the tubing from the top and bottom tubing clamps
8. Remove tubing from around the rotor, being careful with any remaining fluid which may create a hazard.
9. Safely dispose of the used tubing according to local health and safety regulations for contaminated items.
10. Check the rotor rollers spin freely
11. Check the rotor is clean
12. Check the pumphead is clean
13. Mark a 225 mm length onto the section of the tubing which is to be located into the pumphead.



14. Open the lower spring-loaded tube clamp and locate tubing, with the first 225 mm length mark aligned to the inside face of the spring-loaded part of the tube clamp. Release the clamp.



15. Disengage the rotor clutch by fully depressing the yellow clutch button on the side of the rotor hub and turning the hub a few degrees while the clutch button is still depressed. The rotor can now rotate independently of the gearbox and motor for one full revolution. If the clutch re-engages before tube fitting is complete, depress the clutch button again and turn the rotor a few degrees.



16. Feed the tubing around the pumphead track, turning the rotor as necessary. Make sure the tubing is not twisted.



17. Ensure that the second 225 mm mark is adjacent to the inner edge of the upper tube clamp. Open the upper spring-loaded tube clamp and locate the tubing into it, making sure there is no residual twist in the tubing, and that the tube sits centrally between the tube guide rollers. Release the clamp.



18. Check the spring-loaded tube clamps grip the tubing tightly enough to stop it moving in and out of the pumphead but must not over-squeeze the tube. Adjust the sliders to prevent tube movement during a few trial rotations of the rotor. The outer position will allow the clamps to grip the tube tightly and the inner will grip the tube loosely.



19. Close the cover, pushing it fully home until the latch engages.



20. Reconnect the peristaltic tubing to the fluid path in accordance with your organisation's procedure.
21. Bring the pump back into service, checking for any leaks from fluid path connections.
22. If using Marprene or Bioprene, retention the tubing after the first 30 minutes of operation, as the tube may grow in length during this bedding in time. Repeat all previous steps in this procedure to re-tension the tube.

19.3.2.5 500 Series tube element replacement – REL and REM pumpheads

1. Isolate the pump from electrical power.
2. Drain down the fluid path in accordance with your organisation's procedure.
3. Disconnect the peristaltic tubing from the fluid path, in accordance with your organisation's procedure.
4. Unlock the pumphead cover by turning the cover fastener $\frac{1}{4}$ turn anticlockwise with a flat-head screwdriver.



5. Open the cover to its full extent to create maximum clearance for the tube ports.
6. Place one connector end of the element into the lower housing.



7. Disengage the rotor clutch by fully depressing the yellow clutch button on the side of the rotor hub and turning the hub a few degrees while the clutch button is still depressed. The rotor can now rotate independently of the gearbox and motor for one full revolution. If the clutch re-engages before tube fitting is complete, depress the clutch button again and turn the rotor a few degrees.



8. Feed the tubing element around the pumphead track, turning the rotor as necessary.



9. Place the opposite connector end of the element into the top housing. Making sure the element is not twisted and sits centrally between the rollers.



10. Close the cover, pushing it fully home until the latch engages.



11. Connect the peristaltic tubing to the fluid path in accordance with your organisation's procedure.
12. Bring the pump back into service, checking for any leaks from fluid path connections.

19.3.3 Replacing the pumpheads

Follow the procedures below to replace entire pumpheads. If a different pumphead than the original pumphead is required, contact your local Watson-Marlow representative for advice on what pumphead may be installed, and programming of the new pumphead to the drive.

CAUTION



Operating the pump with the incorrect pumphead programmed in the configuration settings can result in the pumphead speed exceeding its maximum design speed. This can result in pumphead failure, drive failure or other hazards because of excessive speed. To avoid these potential hazards, ensure the pumphead model matches the programmed pumphead.

19.3.3.1 100 Series pumphead

1. Isolate pump from power supply.
2. Fully open flip top cover and remove the 2 retaining fasteners.

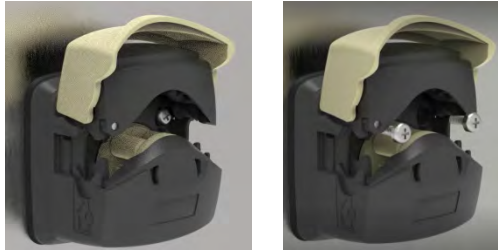

3. Disengage the pumphead from mounting plate and replace with new pumphead.



4. Secure replacement pumphead to mounting plate with 2 retaining fasteners.



19.3.3.2 300 Series pumphead

1. Isolate pump from power supply.
2. Press down clip-on right side of mounting plate and rotate pumphead anticlockwise to disengage from mounting plate.



3. Place new pumphead on to mounting plate and rotate clockwise until the clip moves up and engages the pumphead.



19.3.3.3 400 Series pumphead

400 Series pumpheads are not replaceable. If the RXMD pumphead requires replacement, remove the pump from service and contact your Watson-Marlow representative to discuss how the pump can be repaired or replaced.

Do not attempt to repair or replace the RXMD pumphead.

19.3.3.4 500 Series pumphead

1. Isolate pump from power supply.
2. Unlock the pumphead cover by turning the cover fastener $\frac{1}{4}$ turn anticlockwise.



3. Remove rotor hub by lifting dust cover and removing the securing fastener.

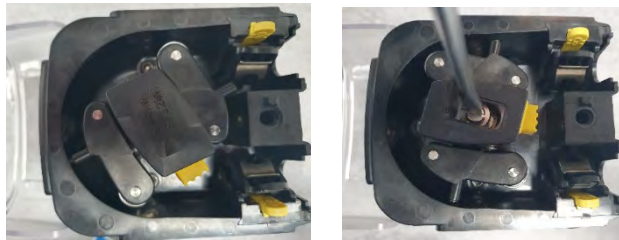

4. Remove the 4 securing fasteners.



5. Remove pumphead from mounting plate and replace with new pumphead.



6. Secure replacement pumphead to mounting plate with 4 retaining fasteners.



7. Attach rotor hub by lifting dust cover and installing securing fastener.

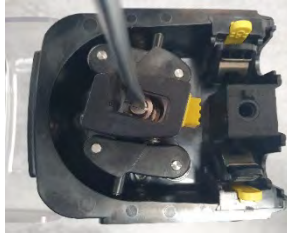

8. Close the pumphead cover and lock by turning the cover fastener $\frac{1}{4}$ turn clockwise



20 Errors, breakdown, and troubleshooting

This section will provide information on errors or a breakdown which may occur during typical operation of the pump, along with potential causes to assist with troubleshooting. It is not possible to provide comprehensive information on errors, breakdown, or troubleshooting, due to the partially completed nature of the product.

If the problem cannot be solved, information on how to seek technical support is provided at the end of this section.

20.1 Errors

All models of a DriveSure pump feature indication of an error. The DriveSure En and Pn models will report a precise error from the list below through the network:

- Motor Stall Error
- Motor Speed Error
- Over Current Error
- Over Voltage Error
- Pumphead cover open
- Under Voltage Error
- Over Temperature
- Software Fault
- Hardware Fault
- Voltage Range Error

An ADC Variant cannot report a precise error from the list above, only indicate that an error exists. The precise error will need to be determined by connecting a DriveSure ADC model to the WM Connect PC software.

20.2 Error reporting

If any unexpected faults or failures are experienced report them to your Watson-Marlow representative.

20.3 Breakdown

20.3.1 Tubing/Element end of life

Peristaltic tubing or element will reach its end of life due to:

- **Wear**—The tubing or element has reached its normal end of life point due to wear.
- **Overpressure**—As a result of being subjected to a pressure greater than the maximum rating of the tubing or element
- **Chemical incompatibility**—As a result of being used with chemicals which are incompatible with the tubing.

If the tubing or element has failed, follow the procedure in the maintenance section for the replacement of the peristaltic tubing or element.

20.4 Troubleshooting

Problem	Possible cause	Solution
Failure to start	No power to drive	Check the power supply, is switch on and the cable is connected.
	Control signal or network command	Check the control cable is securely connected, and a valid signal is applied within the correct range onto the correct control pin.
	Network command	Check the control cable is securely connected, and the correct network command has been programmed.
Pump temperature high	Pump speed too high	Reduce pump speed
	Interruption to power supply resulting in localised excess heating from flow interruption	<ul style="list-style-type: none">• Check power supply is within specification• Check power supply cable is securely connected to pump

Problem	Possible cause	Solution
Reduced fluid flow	Tubing or element bore too small	Increase bore size of tubing or element
	Torque too high resulting in drive unable to produce its highest possible speed for the pumphead	<ul style="list-style-type: none"> • Increase power supply voltage to 48 V DC • Change tube material • Reduce discharge pressure Contact your local Watson-Marlow for information on how maximum speeds are reduced due to power supply voltage or torque (tubing material/pressure)
	Inlet pressure too low	<ul style="list-style-type: none"> • Increase fluid path bore • Decrease fluid path length • Decrease fluid viscosity • Check for fluid path restriction
	Discharge pressure too high	<ul style="list-style-type: none"> • Increase fluid path bore • Decrease fluid path length • Decrease fluid viscosity • Check for fluid path restriction
	Tube clamps not correctly adjusted	Check tubing clamp adjustment using procedures in section 16
Vibration	Pump speed too high	Reduce pump speed. The same flowrates at lower speeds may be achieved by using a larger tube or element bore
	Peak pulsation pressure too high	<ul style="list-style-type: none"> • Reduce pump speed • Increase fluid path bore • Reduce fluid path length
	Fluid path not secured	Secure fluid path correctly.

Problem	Possible cause	Solution
Short tube life	Chemical in-compatibility	Check chemical compatibility of pumped fluid with tubing or element material
	Pump speed too high	Reduce pump speed. The same flowrates at lower speeds may be achieved by using a larger tube or element bore
	Discharge pressure too high	<ul style="list-style-type: none"> • Increase fluid path bore • Decrease fluid path length • Decrease fluid viscosity • Check for fluid path restriction
	Occlusion of tubing incorrect	Check tube clamp setting

20.5 Technical support

Should you be unable to resolve the error or breakdown, or have another query please contact us your Watson-Marlow representative for technical support.

20.5.1 Manufacturer

This product is manufactured by Watson-Marlow. For guidance or support of this product please contact:

Watson-Marlow Limited
Bickland Water Road
Falmouth, Cornwall
TR11 4RU
United Kingdom

Phone: +44 1326 370370
Website: <https://www.wmfts.com/>

20.5.2 Authorised EU Representative

Johan van den Heuvel
Managing Director

Watson Marlow Bredel B.V.
Sluisstraat 7
Delden
Netherlands
PO Box 47

Telephone: +31 74 377 0000

20.6 Warranty

Watson-Marlow Limited ("Watson-Marlow") warrants this product to be free from defects in materials and workmanship for two years from the date of shipment, under normal use and service.

Watson-Marlow's sole responsibility and the customer's exclusive remedy for any claim arising out of the purchase of any product from Watson-Marlow is, at Watson-Marlow's option: repair, replacement, or credit, where applicable.

Unless otherwise agreed in writing, the foregoing warranty is limited to the country in which the product is sold.

No employee, agent or representative of Watson-Marlow has the authority to bind Watson-Marlow to any warranty other than the foregoing unless in writing and signed by a director of Watson-Marlow. Watson-Marlow makes no warranty of the fitness of its products for a particular purpose.

In no event:

- shall the cost of the customer's exclusive remedy exceed the purchase price of the product;
- shall Watson-Marlow be liable for any special, indirect, incidental, consequential, or exemplary damages, however arising, even if Watson-Marlow has been advised of the possibility of such damages.

Watson-Marlow shall not be liable for any loss, damage, or expense directly or indirectly related to or arising out of the use of its products, including damage or injury caused to other products, machinery, buildings, or property. Watson-Marlow shall not be liable for consequential damages, including, without limitation, lost profits, loss of time, inconvenience, loss of product being pumped, and loss of production.

This warranty does not obligate Watson-Marlow to bear any costs of removal, installation, transportation, or other charges which may arise in connection with a warranty claim.

Watson-Marlow shall not be responsible for shipping damage of returned items.

20.6.1 Conditions

- Products must be returned by pre-arrangement to Watson-Marlow, or a Watson-Marlow approved service centre.
- All repairs or modifications must have been made by Watson-Marlow Limited, or a Watson-Marlow approved service centre or with the express permission in writing of Watson-Marlow, signed by a manager or director of Watson-Marlow.
- Any remote control or system connections must be made in accordance with Watson-Marlow recommendations.
- All EtherNet/IP systems must be installed or certified by a EtherNet/IP approved installation engineer.
- All PROFINET systems must be installed or certified by a PROFINET approved installation engineer.

20.6.2 Exceptions

- Consumable items including tubing and pumping elements are excluded.
- Pumphead rollers are excluded.
- Repairs or service necessitated by normal wear and tear or by lack of reasonable and proper maintenance are excluded.
- Products which, in the judgement of Watson-Marlow, have been abused, misused, or subjected to malicious or accidental damage or neglect are excluded.
- Failure caused by electrical surge is excluded.
- Failure caused by incorrect or sub-standard system wiring is excluded.
- Damage by chemical attack is excluded.
- Ancillaries such as leak detectors are excluded.
- Failure caused by UV light or direct sunlight.
- Any attempt to disassemble a Watson-Marlow product will invalidate the product warranty.

Watson-Marlow reserves the right to amend these terms and conditions at any time.

20.7 Returning products

Before returning products, they must be thoroughly cleaned/decontaminated. A decontamination declaration, confirming this must be completed and returned to us in advance of the item being shipped.

You are required to complete and return a decontamination declaration stating all fluids that have been in contact with the equipment being returned to us.

On receipt of the declaration, a Returns Authorisation Number will be issued. Watson-Marlow reserves the right to quarantine or refuse any equipment that is not displaying a Returns Authorisation Number.

Please complete a separate decontamination declaration for each product and use the correct form that denotes the location you wish to return the equipment to.

To obtain a decontamination declaration document for completion, contact your local Watson-Marlow representative.

21 Chemical compatibility

21.1 Overview

Chemical incompatibility with product materials of construction, could result in the creation of a hazard which would affect the pump, personnel or the operating environment.

A responsible person, must follow the chemical compatibility procedure in section 21.4 to determine if the product is suitable for the intended application in accordance with the user organisations policies and risk control methods.

Section 21.3 introduces the material of construction by item group concept prior to reference during the chemical compatibility procedure in section 21.4

21.2 Materials of construction



21.2.1 Abbreviations (sub section)

The following abbreviations may be used in this section:

Abbreviation	Full name
ABS	Acrylonitrile butadiene styrene
ePTFE	Expanded Polytetrafluoroethylene
PARA	Polyacrylamide
PBT	Polybutylene Terephthalate
PC	Polycarbonate
PPS	Polyphenylene sulphide
PTFE	Polytetrafluoroethylene
PVC	Polyvinylchloride
PVDF	Polyvinylidene difluoride
SEBS	Styrene-ethylene-butylene styrene

21.2.2 Identification of item groups

Materials of construction are grouped according to the picture and table below:

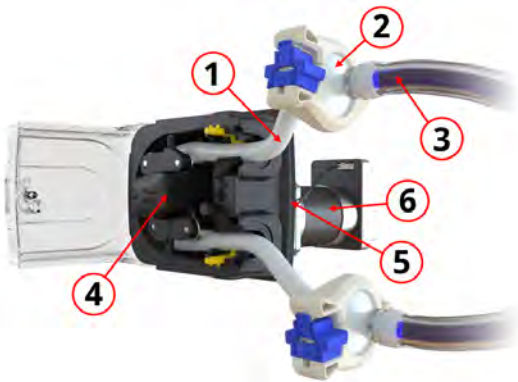
100 Series		300 Series	
			
400 Series		500 Series	
			
Item group number	Item group name		
1	Fluid path tubing/pipework		
2	Fluid path connection		
3	Peristaltic tubing (or element)		
4	Pumphead		
5	Pumphead mounting plate assembly		
6	Drive		

21.2.3 Materials of construction of item groups

The material of construction of each item group is provided in the sub sections below:

21.2.3.1 Item group 1: Peristaltic tubing (or element)

Tubing name	Material
Marprene	Thermoplastic elastomer
Bioprene	Thermoplastic elastomer
Pumpsil	Platinum cured silicone
Pureweld XL	SEBS
Sta-Pure PCS	ePTFE and platinum-cured silicone composite
Sta-Pure PFL	ePTFE and platinum-cured perfluoroelastomer
Tygon E-LFL	PVC
Tygon E-3603	PVC

In addition to the tubing material, LoadSure elements, which are used with the 520REL and 520REM pumpheads, have PVDF fluid connectors built into it.

21.2.3.2 Item group 2: Fluid path connection

For applications using a fluid path connection, the materials of construction of this connection must be considered.

The fluid connection may be a single item such as tube to tube barb, or may be a multi part item including a

- Fluid connector
- Fluid connector seal
- Clamp or other fastener to bind connections

For Watson-Marlow supplied product contact your local Watson-Marlow representative to discuss the materials of construction of this item group. LoadSure elements, which are used with the 520REL and 520REM pumpheads, have PVDF fluid connectors built into the element.

21.2.3.3 Item group 3: Fluid path tubing/pipework

The fluid path tubing or pipework may be single or multi material item. For Watson-Marlow supplied product contact your local Watson-Marlow representative to discuss the materials of construction of this item group.

21.2.3.4 Item group 4: Pumphead

Subcomponent name	Material			
	100 Series	300 Series	400 Series	500 Series
Pumphead body assembly	Grilamid PA12	Glass filled polypropylene	Anodised Aluminium	Acetal
	PARA (IXEF)	PARA (IXEF)		Aluminium
		Stainless steel		Aluminium alloy
				Brass
Pumphead rotor assembly	PARA (IXEF)	Electroless nickel plated hardened steel	Anodised Aluminium	PPS
		Glass filled nylon		Stainless steel 316
Pumphead roller assembly	PTFE filled PBT	MoS2 filled Nylon 6 (Nylatron)	Stainless Steel	MoS2 filled Nylon 6 (Nylatron)
				PPS
				Stainless steel 316
Pumphead cover	PARA (IXEF)	PARA (IXEF)	Acrylic Glass	PC
Pumphead track	PARA (IXEF)	PARA (IXEF)	Anodised Aluminium	PPS

21.2.3.5 Item group 5: Pumphead mounting plate assembly

Subcomponent name	Material of construction			
	100 Series	300 Series	400 Series	500 Series
Mounting plate	PARA (Halogen free, UL94 V-0 rated)	PARA (Halogen free, UL94 V-0 rated)	Aluminium	PARA (Halogen free, UL94 V-0 rated)
Mounting plate seal	Thermoplastic elastomer (TPE)	Thermoplastic elastomer (TPE)	N/A	Thermoplastic elastomer (TPE)
Shaft seal	Nitrile	Nitrile	N/A	Nitrile
Gearbox fixing screws	N/A	N/A	N/A	Stainless steel
O-ring seal	N/A	N/A	N/A	Nitrile

21.2.3.6 Item group 6: Drive

Subgroup	Subcomponent name	Material			
		100 Series	300 Series	400 Series	500 Series
Motor	Motor endcaps	Aluminium			
	Driveshaft	Plasma nitride coated stainless steel			N/A
Gearbox	Gearbox casing	N/A	N/A	N/A	Aluminium
	Driveshaft	N/A	N/A	N/A	Stainless steel
	Driveshaft seal	N/A	N/A	N/A	Nitrile
Controller	Housing (Rear)	ABS/PC, Aluminium			
	Housing (Front)	Aluminium			
	Light pipe	PC			
	Fixing screws	Stainless steel			

21.3 Procedure to check chemical compatibility

1. Using section 21.3.3, Determine the materials of construction that would be wetted by scenario 1A and 1B:

1A: Item group 1, 2 and 3: Normally wetted by the fluid path

1B: Item group 4, 5 and 6: Not normally wetted, or have the potential to be wetted by the following:

- Spillage or leakage of the fluid path
- By chemicals (liquid or gas) in the operating environment
- During cleaning or decontamination
- If the pump is operated to the point that the tubing or element fails, resulting in spillage or leakage of the pumped fluid onto materials of construction in item group 4 (pumphead), item group 5 (pumphead mounting plate assembly)

2. Determine chemical compatibility of the materials of construction identified in Step 1, using 2A and 2B:

2A. For products with a Watson-Marlow product code, use the Watson-Marlow Chemical Compatibility Guide:

<https://www.wmfts.com/en/support/chemical-compatibility-guide/>

For tubing and elements, use the tubing name.

2B. For products not purchased from Watson-Marlow, use supplier chemical compatibility guides

3. Do a risk assessment to determine the effect, and risk control methods a responsible person may take as a result of failure due to chemical incompatibility with the materials of construction, resulting in the following hazards:

- Chemical hazard from release of chemicals
- Physical hazard from the release of pressure or material fragments
- Other hazards not listed here

4. Using the hazard analysis and identified risk control methods in step 3, in accordance with the users organisations policies, a responsible person must decide if the product is suitable for the intended application.

22 Compliance





22.1 Compliance marking

22.1.1 Location of compliance marking

The product is marked to demonstrate compliance. These markings may be identified on the product in the location, illustrated by the picture below:



22.1.2 Description of compliance marking

Compliance mark	Description
	Complies with the applicable marking regulations, listed on the Declaration of Incorporation.
	Complies with the applicable marking regulations, listed on the Declaration of Incorporation.
	Certified by TUV to: <ul style="list-style-type: none"> • IEC 61010-1:2010/AMD1:2016 • EN 61010-1:2010/A1:2019 • UL 61010-1:2012/R:2019-07 • CSA C22.2 No. 61010-1-12/AMD1:2018
	Complies to the applicable requirements of ACMA (Australian Communications and Media Authority)

22.2 Certification and declaration

22.2.1 EU declaration of incorporation

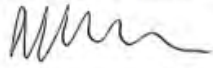
	Fluid Technology Solutions
EU declaration of incorporation	
<ol style="list-style-type: none">1. Manufacturer: Watson Marlow Limited, Bickland Water Road, Falmouth, TR11 4RU, UK2. This declaration of incorporation is issued under the sole responsibility of the manufacturer.3. Object of the Declaration: DriveSure En, DriveSure Pn, DriveSure ADC.4. The object of the declaration described above conforms in part with the relevant Union harmonisation legislation: <i>Machinery Directive 2006/42/EC</i>5. The object of the declaration described above conforms with the following directive(s): <i>EMC Directive 2014/30/EU, RoHS Directive 2011/65/EU</i>6. The following standards have been applied: <i>IEC 61010-1:2010/AMD1:2016</i> <i>EN 61010-1:2010/A1:2019</i> <i>UL 61010-1:2012/R:2019-07</i> <i>CSA C22.2 No. 61010-1-12/AMD1:2018</i> <i>BS EN IEC 61326-1:2021</i>7. We undertake to transmit, in response to a reasoned request by the appropriate national authorities, relevant information on the partly completed equipment identified above. The method of transmission shall be by mail or email.8. The product is incomplete and must not be put into service until the machinery into which it is to be incorporated has been declared in conformity with the provisions of the Directive(s).	
Signed for on behalf of: Watson-Marlow Limited Falmouth, 22nd November 2023 	Person authorized to compile the technical documents: Johan van den Heuvel Managing Director Watson Marlow Bredel B.V. Sluisstraat 7 Delden Netherlands PO Box 47 Telephone: +31 74 377 0000
Nancy Ashburn, Head of Design & Engineering, Watson-Marlow Limited Watson-Marlow Fluid Technology Solutions Telephone: +44 (0) 1326 370370 A Spirax-Sarco Engineering plc company	

PB100800/1.1